

TILE

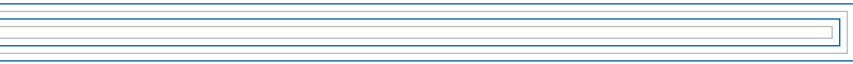

METAL CEILING SYSTEMS

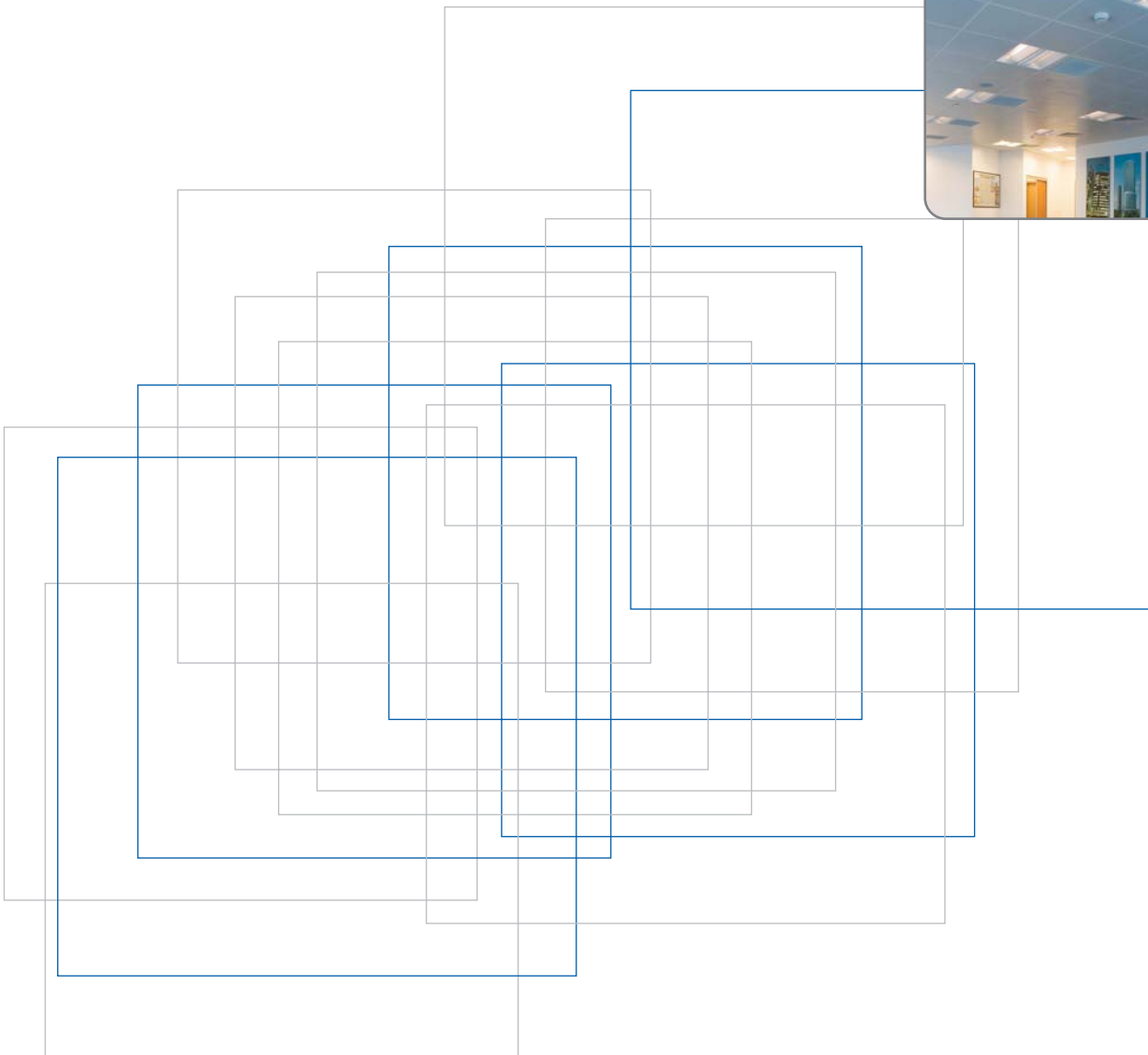

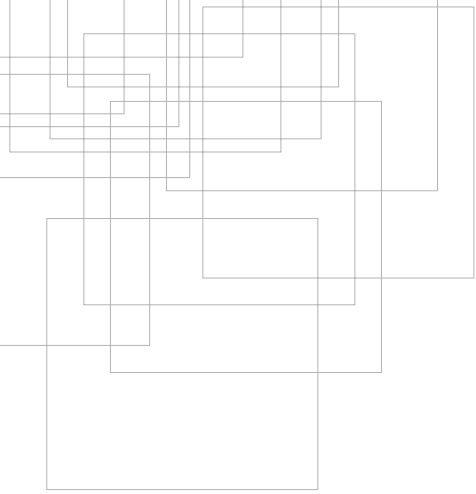

INTEGRA TILE



INTEGRA PLANK



INTEGRA OPEN CELL

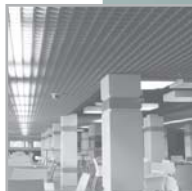

INTEGRA EXPANDED



INTEGRA SPECIALS





CLIP-IN TILE



CLIP-IN
STANDARD



CLIP-IN
NONIUS

LAY-IN TILE



LAY-IN TEGULAR
LAY-IN DEEP TEGULAR



LAY-IN FLAT

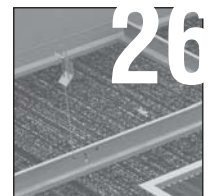

LAY-IN MICROLOOK

ADDITIONAL INFORMATION



WALL JOINTING DETAILS
INTEGRATION AND LIGHTING
COLOUR AND PATTERN
PERFORMANCE
ACOUSTICS
FIRE
MAINTENANCE GUIDE



INTEGRA TILE

Integra offers a vast range of specially chosen standard ceiling types. Integra Tile is the right choice when steady delivery and installation, reasonable price and above all; high quality, acoustic performance and aesthetics appearance are required.





CLIP-IN STANDARD

Integra Tile Clip-in Panels, offer a monolithic ceiling appearance through the concealed suspension system. Integra Clip-in tiles are available in galvanized steel, aluminium and offer the advantage of independent demounting and easy access to the plenum. The Integra Clip-in system can be used in offices, production plants, computer rooms, as well as public transportation locations such as airports and subways.





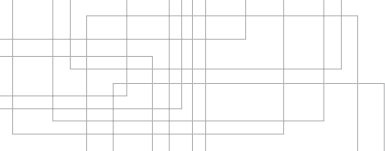

CLIP-IN STANDARD

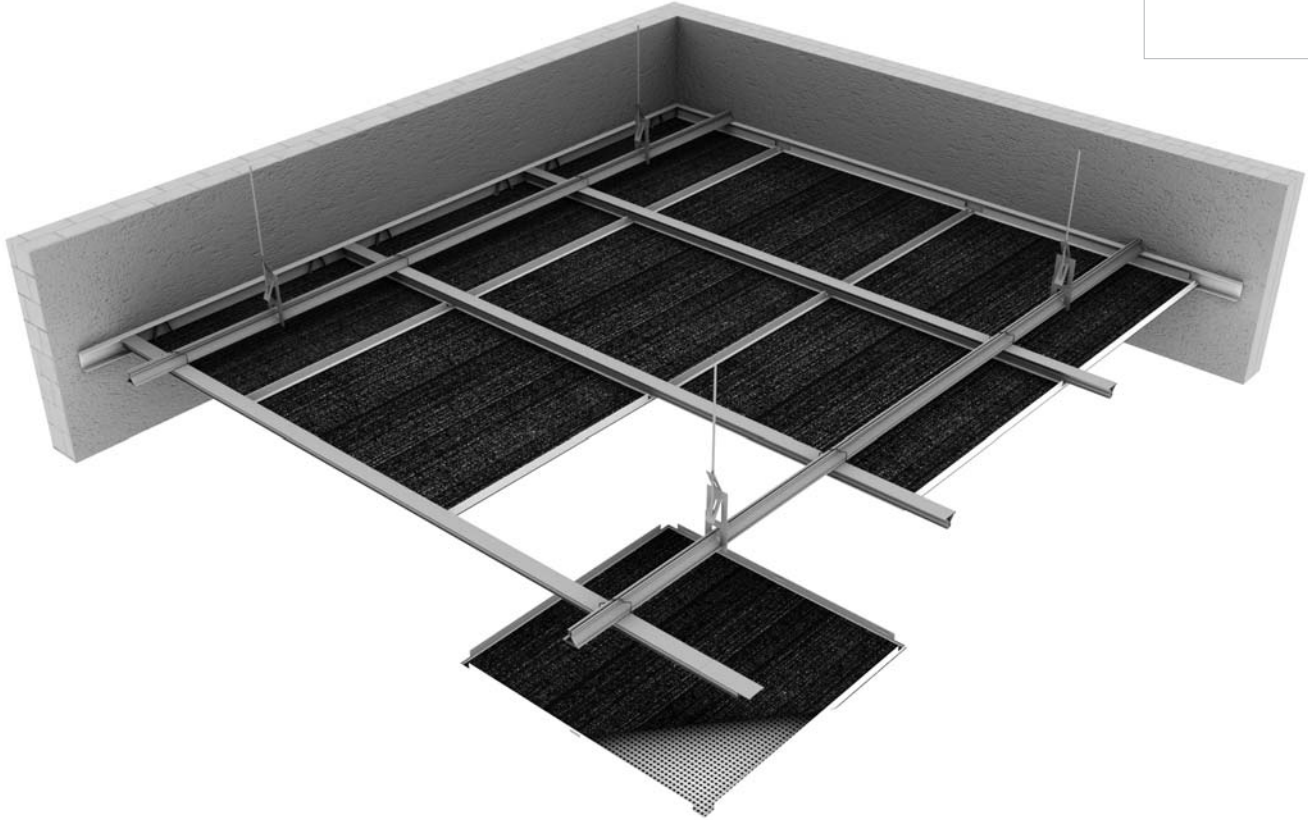

Material	Galvanized Steel, Aluminum
Dimensions	300x300, 600x600 mm
Standard Perforation (mm)	Ø0.7, Ø1.5, Ø1.8, Ø2.5, Ø3.0, Ø7.0
Special Perforation (mm)	Ø4.5, Ø12.0, 8x8 square (For detailed information on perforations pls. see pp. 41-45)
Standard Colours	RAL 9010 and RAL 9006 <ul style="list-style-type: none">• Production is possible in all other RAL Colours upon request.• Antibacterial paint option is available upon request, especially for areas with hygiene requirements.• Panels with wood appearance can be produced if requested. (For detailed information on Colours pls. see pp. 37-39)
Areas of Use	Offices, production facilities, airports, shopping centers, metro stations and especially spaces such as kitchens and hospitals where hygiene is important.
Acoustics	NRC: 0.60 - 0.70 (For detailed information pls. see pp. 47-55)
Fire	Resistance to Fire class B-s1, d0 (For detailed information pls. see pp. 57-59)



CLIP-IN STANDARD

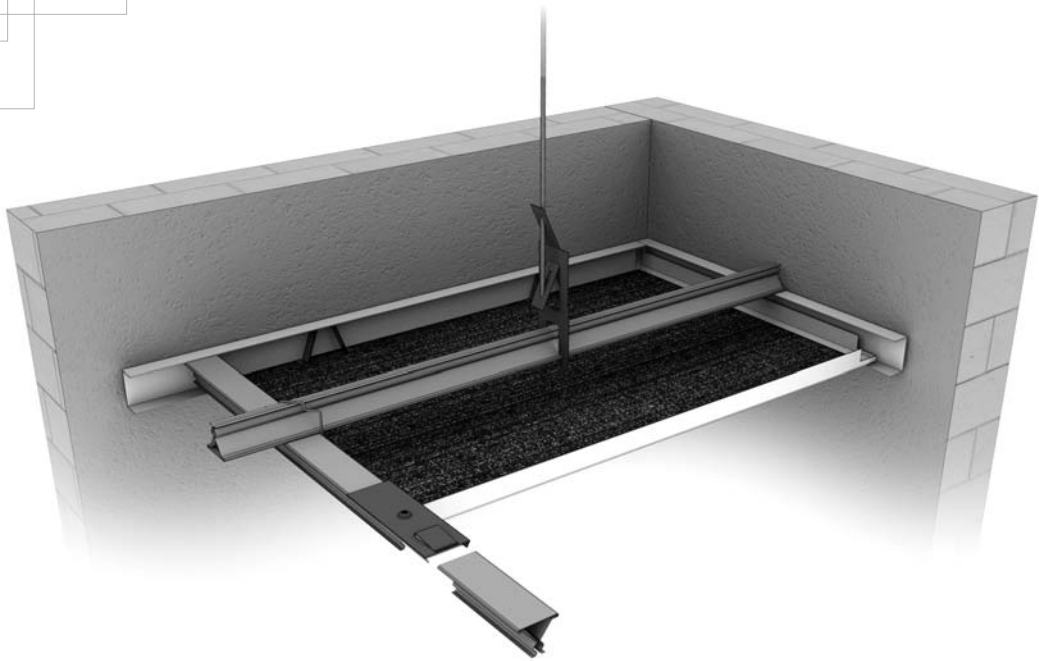

Accessories



01

52010001 CLPN-400 Clip-in Profile	
Dimensions (mm)	29x32x4000x0,5
Packaging Details	40 m/carton
Weight	0,51 kg/m



03

52010006 AH 209 Coupling Clip	
Dimensions (mm)	
Packaging Details	1000 pc/carton
Weight	0,003 kg/pc

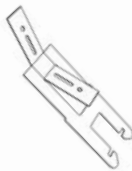

02

52010016 CLM-35 Hanger Clip	
Dimensions (mm)	154
Packaging Details	250 pc/carton
Weight	0,03 kg/pc

Accessories Joint Details

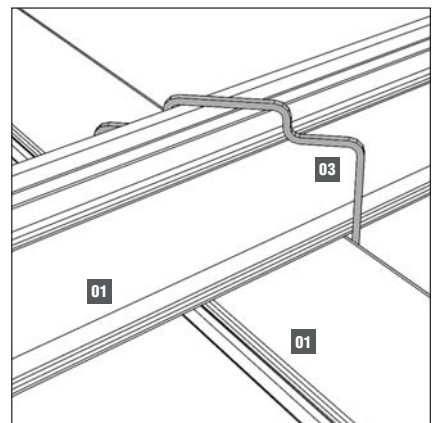
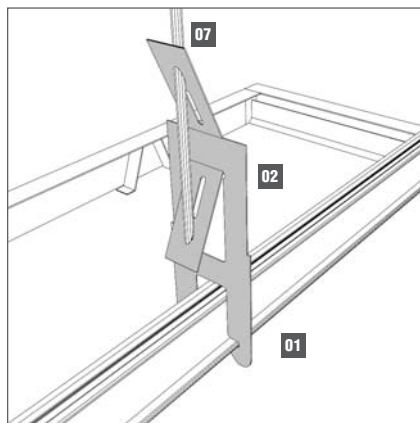

CLIP-IN STANDARD

SYSTEM DETAIL

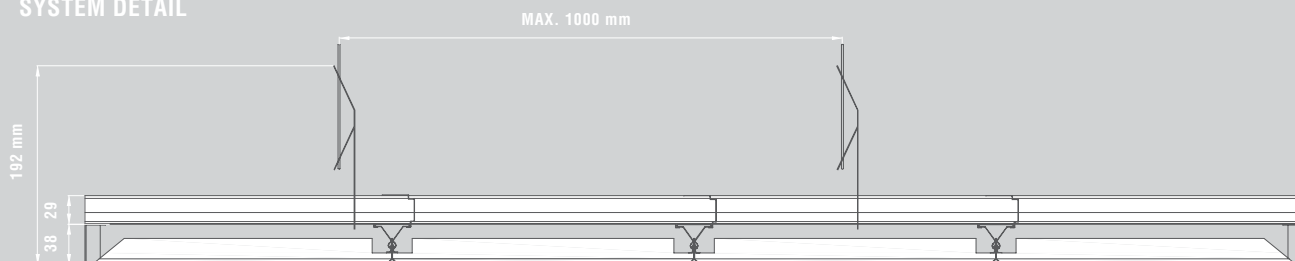

EDGE OPTIONS

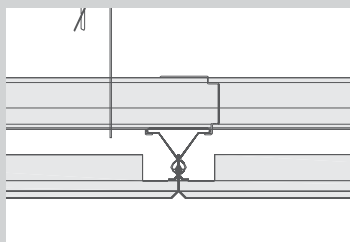

BEVELLED

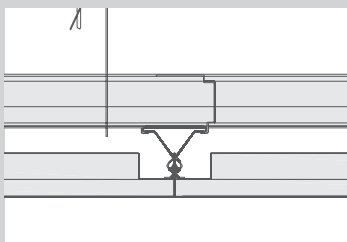

SQUARE

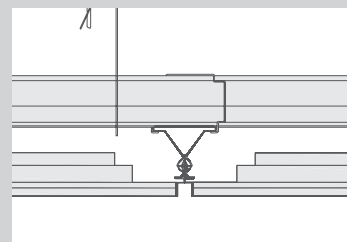

PLUTO

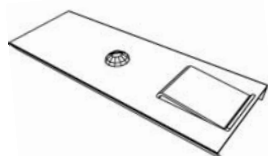

04

52010005 AH 37 Clip-in Profile Splice

Dimensions (mm)	145
Packaging Details	500 pc/carton
Weight	0,026 kg/pc



05

52010021 CDPR 310 C-Wall Angle

Dimensions (mm)	20x40x20x3000x0,5
Packaging Details	96 m/carton
Weight	0,326 kg/m



07

17010104 DST-1 Hanger Wire

Dimensions (mm)	1000
Packaging Details	500 pc/carton
Weight	0,10 kg/pc



06

52010008 KT 40 Wedge Clip

Dimensions (mm)	
Packaging Details	500 pc/carton
Weight	0,008 kg/pc



08

17020101 TP-02 Steel Anchor

Dimensions (mm)	
Packaging Details	500 pc/carton
Weight	0,018 kg/pc

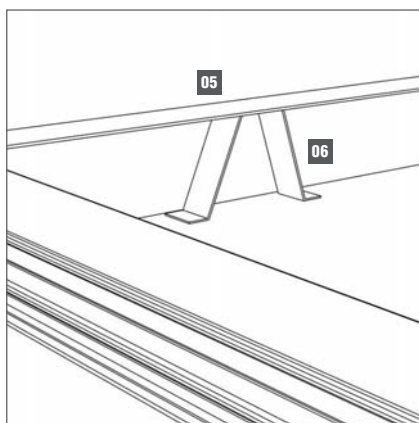
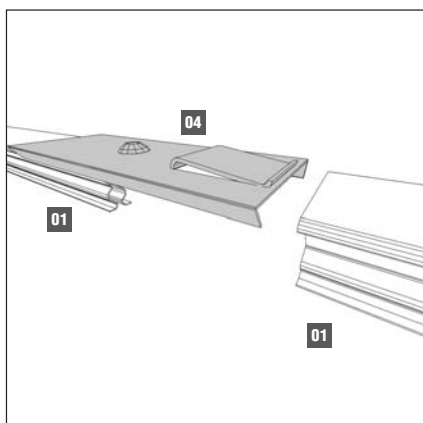

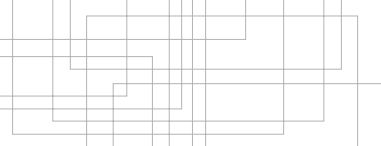



CLIP-IN NONIUS

Using a nonius hanger is a better choice when installing a more rigid ceiling with the Clip-in System, especially in areas such as metro stations.

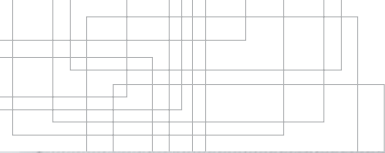

CLIP-IN NONIUS

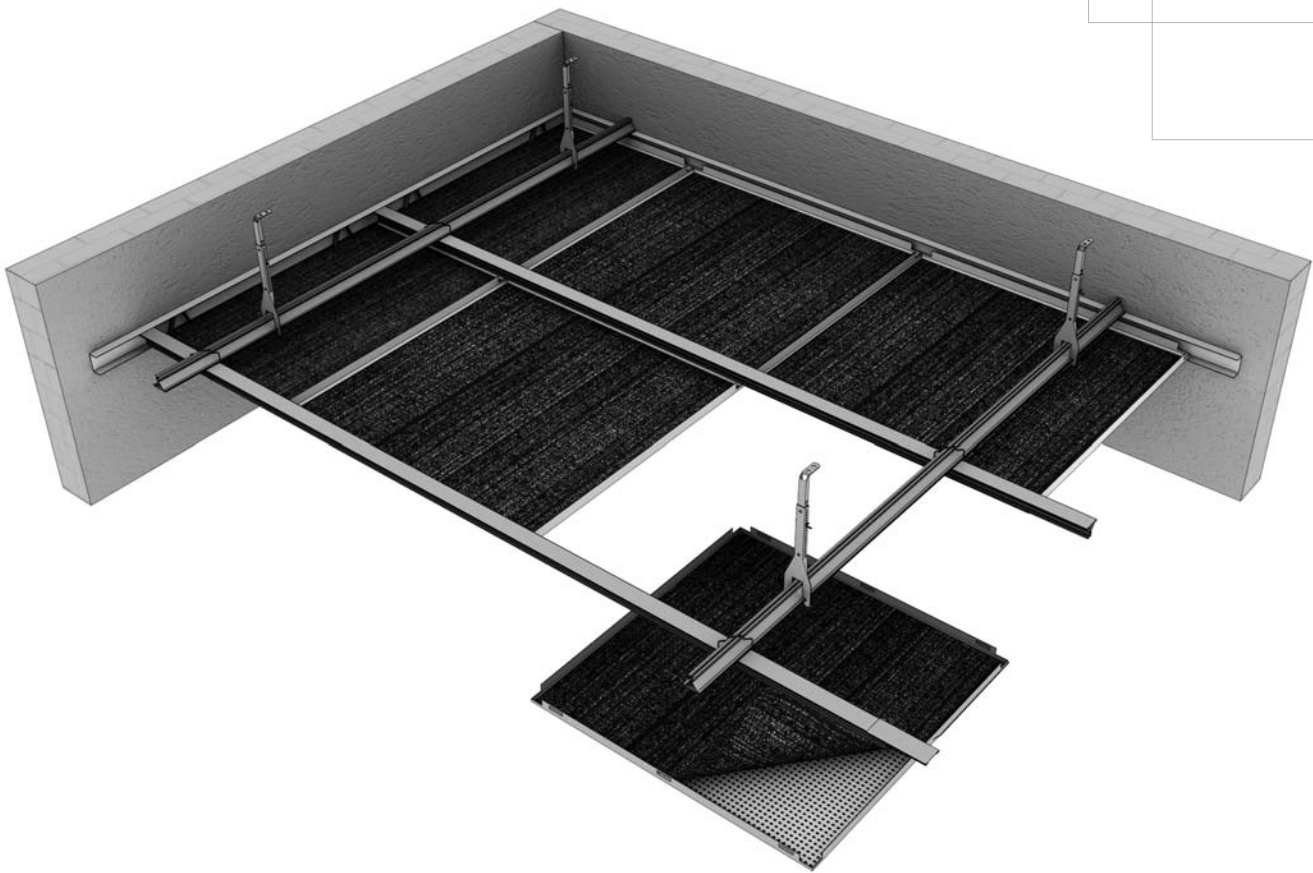

Material	Galvanized Steel, Aluminum
Dimensions	300x300, 600x600 mm
Standard Perforation (mm)	Ø0.7, Ø1.5, Ø1.8, Ø2.5, Ø3.0, Ø7.0
Special Perforation (mm)	Ø4.5, Ø12.0, 8x8 square (For detailed information on perforations pls. see pp. 41-45)
Standard Colours	RAL 9010 and RAL 9006 <ul style="list-style-type: none">• Production is possible in all other RAL colours upon request.• Antibacterial paint option is available upon request, especially for areas with hygiene requirements.• Panels with wood appearance can be produced if requested. (For detailed information on Colours pls. see pp. 37-39)
Areas of Use	Production facilities, airports, shopping centers, metro stations.
Acoustics	NRC: 0.60 - 0.70 (For detailed information pls. see pp. 47-55)
Fire	Resistance to Fire class B-s1, d0 (For detailed information pls. see pp. 57-59)



CLIP-IN NONIUS

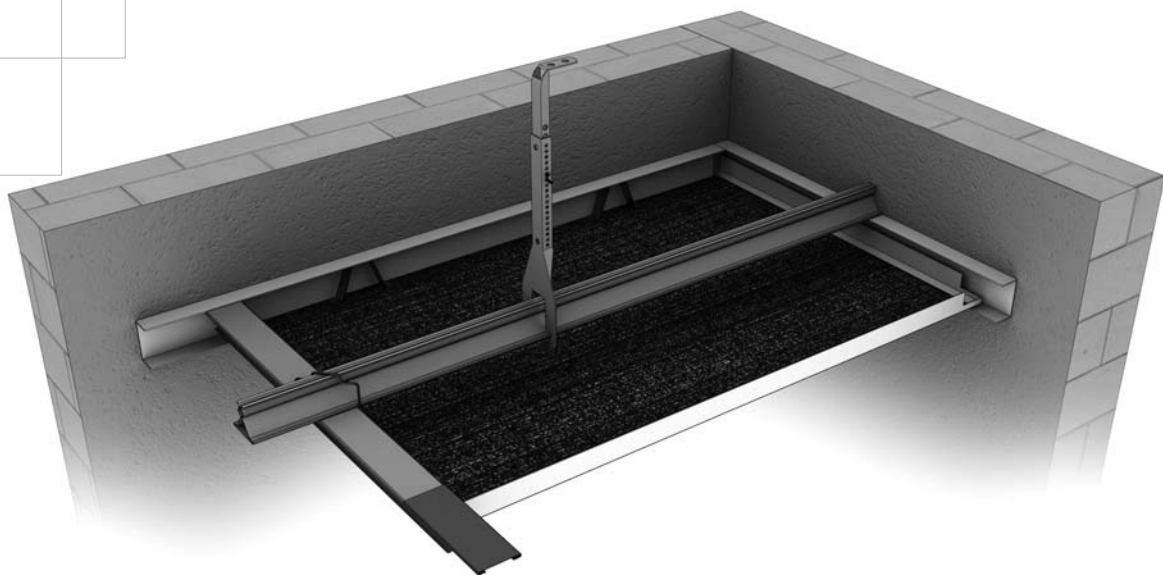

Accessories



01

52010001 CLPN-400 Clip-in Profile

Dimensions (mm)	29x32x4000x0,5
Packaging Details	40 m/carton
Weight	0,51 kg/m



03

52030025 NU-100 Nonius Rigid Hanger-Upper

Dimensions (mm)	1000
Packaging Details	100 pc/packaging
Weight	0,015 kg/pc



02

52010019 CLM-35-N Nonius Rigid Hanger-Lower

Dimensions (mm)	182
Packaging Details	100 pc/carton
Weight	0,042 kg/pc

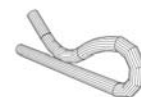

04

52030026 1/14 Nonius Connection Pin

Dimensions (mm)	
Packaging Details	200 pc/carton
Weight	0,006 kg/pc

Accessories Joint Details

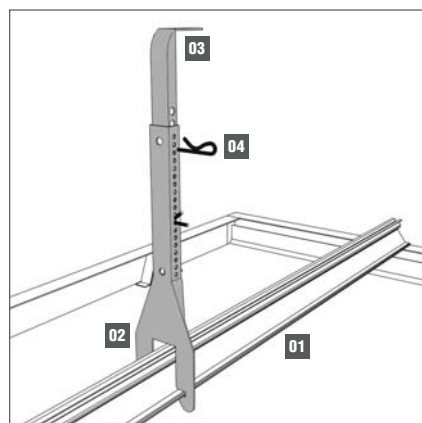

CLIP-IN NONIUS

SYSTEM DETAIL

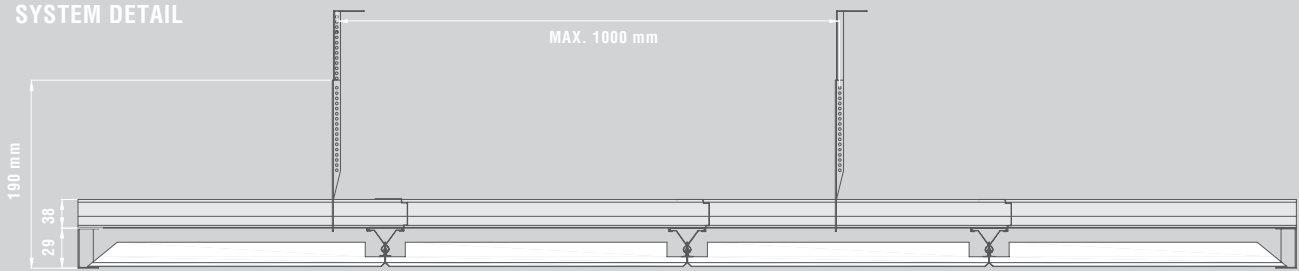

EDGE OPTIONS

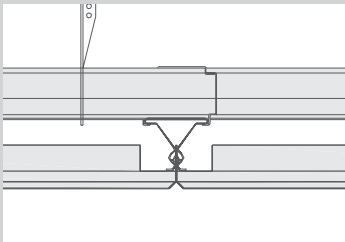

BEVELLED

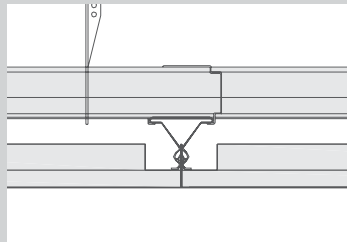

SQUARE

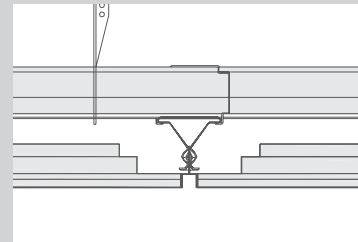

PLUTO



05

52010006 AH 209 Coupling Clip

Dimensions (mm)	
Packaging Details	1000 pc/carton
Weight	0,003 kg/pc



07

52010021 CDPR 310 C-Wall Angle

Dimensions (mm)	20x40x20x3000x0,5
Packaging Details	96 m/carton
Weight	0,326 kg/m



09

17020101 TP-02 Steel Anchor

Dimensions (mm)	
Packaging Details	500 pc/carton
Weight	0,018 kg/pc



06

52010005 AH 37 Clip In Profile Splice

Dimensions (mm)	145
Packaging Details	500 pc/carton
Weight	0,026 kg/pc



08

52010008 KT 40 Wedge Clip

Dimensions (mm)	
Packaging Details	500 pc/carton
Weight	0,008 kg/pc

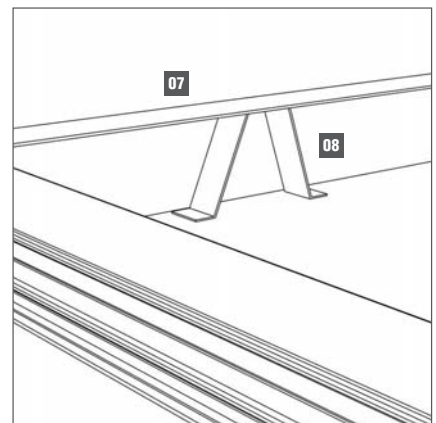
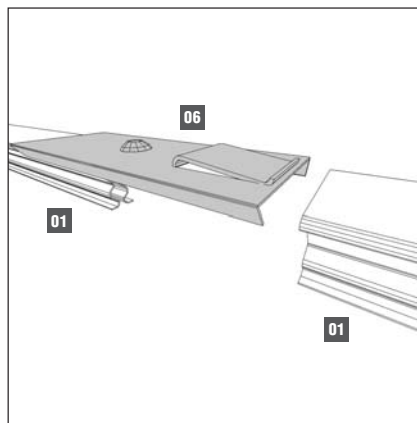
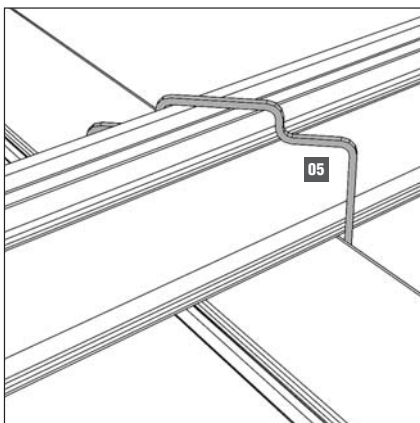

LAY-IN TEGULAR LAY-IN DEEP TEGULAR

Integra Lay-in panels, which offer different alternatives for modern ceiling designs, are composed of two main groups: Tegular and Deep Tegular. The Tegular Lay-in panels have 8 mm recessed from the T-24 system. The Deep Tegular panels enhance the gap effect with a 12 mm recessed. Available in galvanized steel and aluminium, Integra Lay-in panels can be custom-designed and produced with the possibility of different recessed dimensions. The Tegular / Deep Tegular Lay-in system offers the ideal solution for particularly renovation projects in particular.





LAY-IN TEGULAR / LAY-IN DEEP TEGULAR

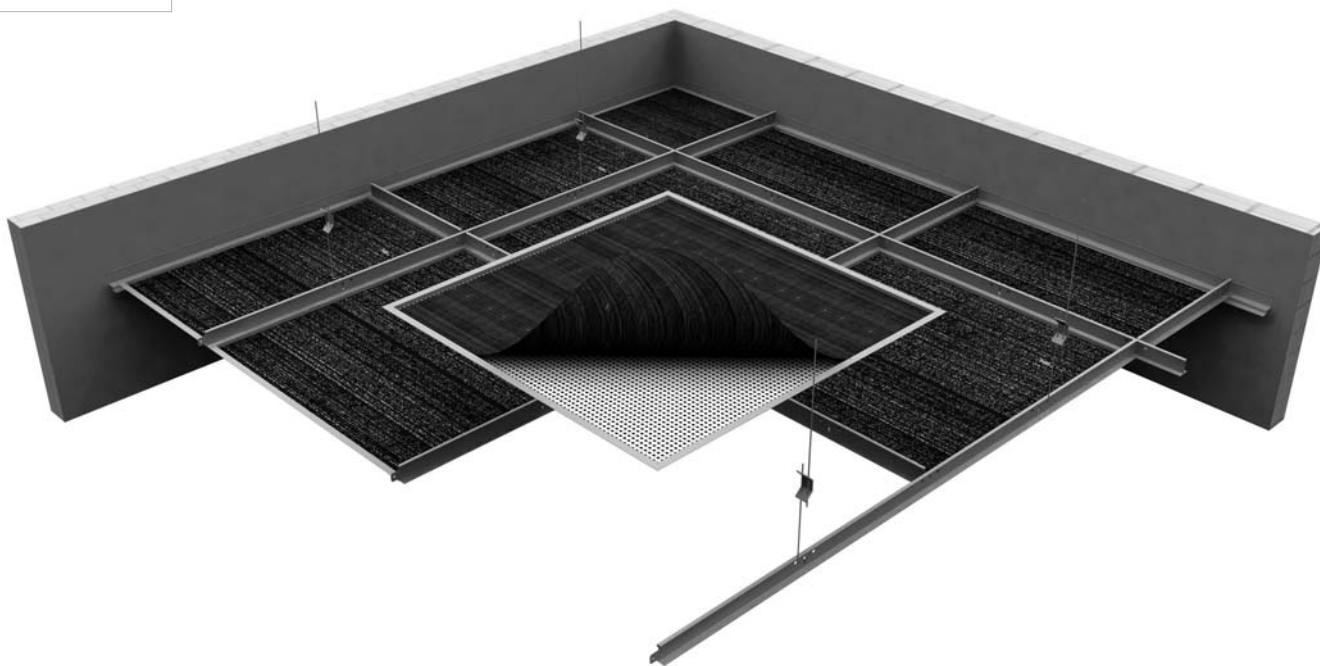

Material	Galvanized Steel, Aluminum
Dimensions	600x600 mm
Standard Perforation (mm)	Ø0.7, Ø1.5, Ø1.8, Ø2.5, Ø3.0, Ø7.0
Special Perforation (mm)	Ø4.5, Ø12.0, 8x8 square (For detailed information on perforations pls. see pp. 41-45)
Standard Colours	RAL 9010 and RAL 9006 <ul style="list-style-type: none">• Production is possible in all other RAL Colours upon request.• Antibacterial paint option is available upon request, especially for areas with hygiene requirements.• Panels with wood appearance can be produced if requested. (For detailed information on Colours pls. see pp. 37-39)
Areas of Use	Renovation projects, offices, shopping centers, airports
Acoustics	NRC: 0.60 - 0.70 (For detailed information pls. see pp. 47-55)
Fire	Resistance to Fire class B-s1, d0 (For detailed information pls. see pp. 57-59)



LAY-IN TEGULAR / LAY-IN DEEP TEGULAR

SYSTEM DETAIL

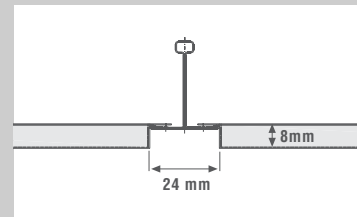
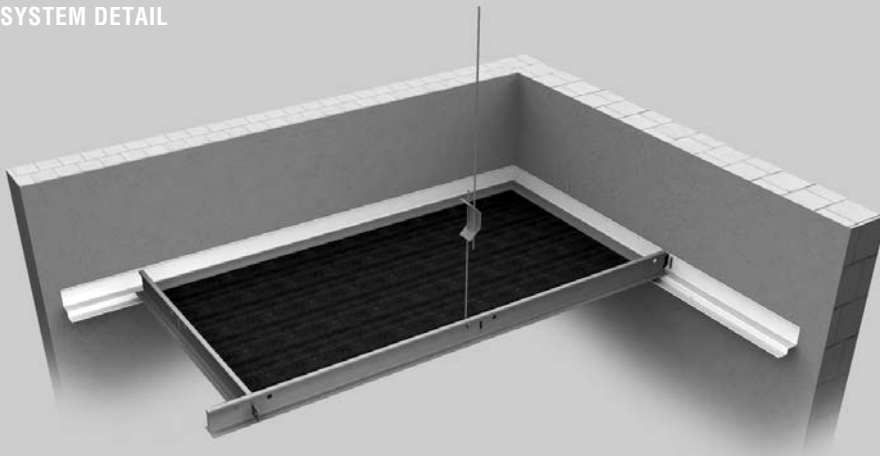

Tegular

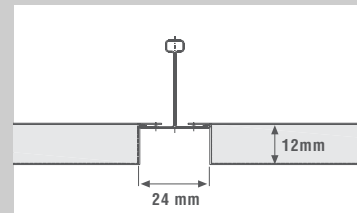

Deep Tegular



Accessories

01

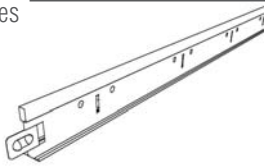

52040101 AS-GR24-B01 T24 Main Runner-3600

Dimensions (mm)	24x38x3600x0,4
Packaging Details	90 m/carton
Weight	1,344 kg/pc

03



52040102 AS-GR24-B03 T24 Cross Runner - 600

Dimensions (mm)	24x30x600x0,4
Packaging Details	45 m/carton
Weight	0,187 kg/pc

05



13011128 HDVC/4 Double Spring Clip

Dimensions (mm)	
Packaging Details	500 pc/carton
Weight	0,0082 kg/pc

02



52040102 AS-GR24-B02 T24 Cross Runner - 1200

Dimensions (mm)	24x30x1200x0,4
Packaging Details	60 m/carton
Weight	0,3896 kg/pc

04

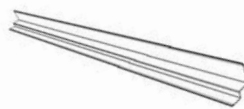

52040902 AS-GR1508-B05 Z - Wall Angle

Dimensions (mm)	25x15x8x15x3050x0,5
Packaging Details	106,75 m/carton
Weight	0,79 kg/pc

06



17010104 DST-01 Hanger Wire

Dimensions (mm)	1000
Packaging Details	500 pc/carton
Weight	0,10 kg/pc

Accessories Joint Details

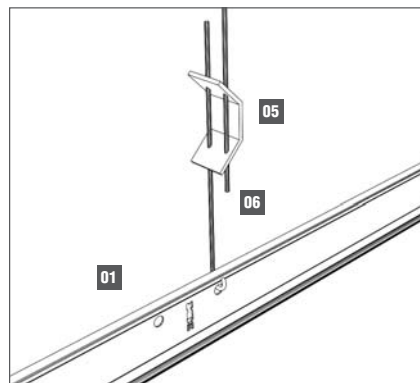
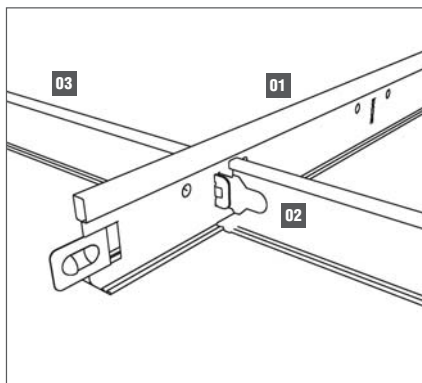

07



17020101 TP-02 Steel Anchor

Dimensions (mm)	
Packaging Details	500 pc/carton
Weight	0,018 kg/pc



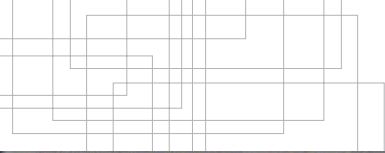



LAY-IN FLAT

Integra Flat Lay-in panels are fully compatible with various T-24 suspension systems and are available in galvanized steel and aluminium. As with all other Lay-in systems, Flat Lay-in panels can also be easily demounted without the need for tools.

LAY-IN FLAT

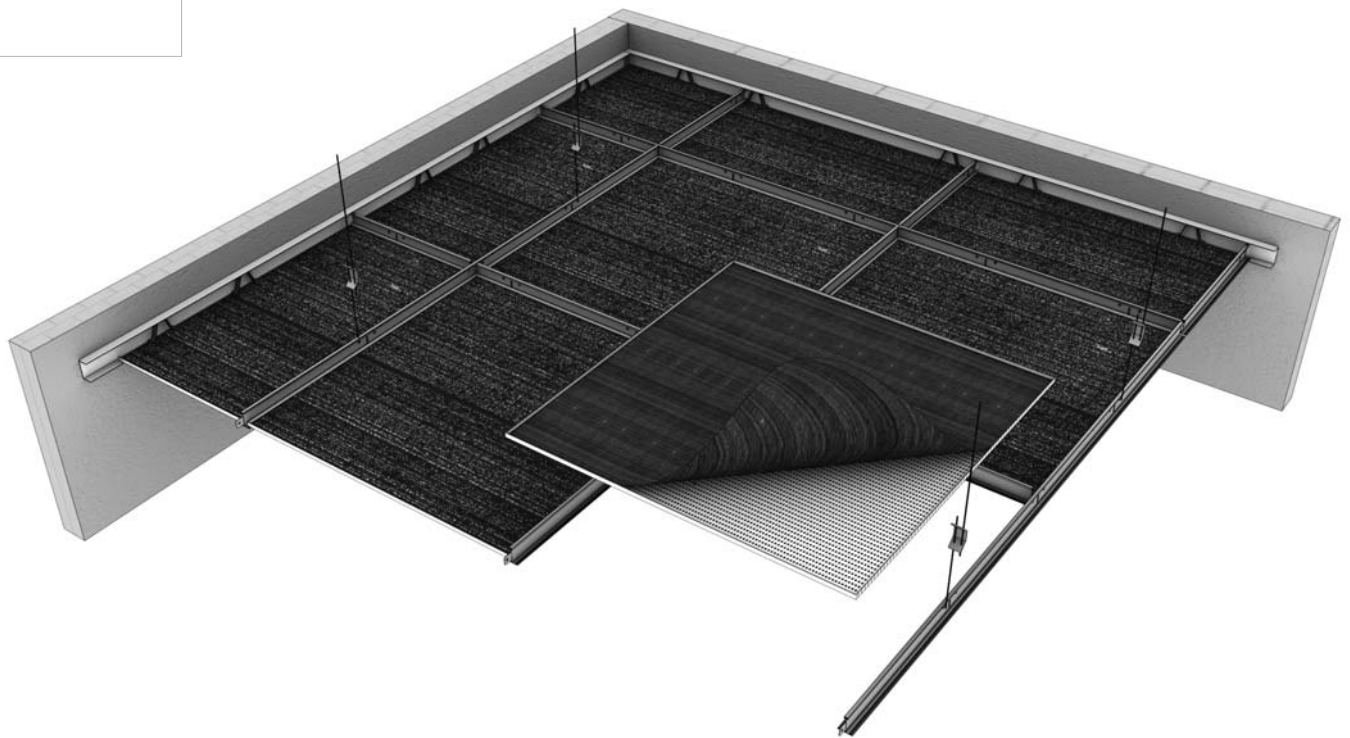

Material	Galvanized Steel, Aluminum
Dimensions	600x600 mm
Standard Perforation (mm)	Ø0.7, Ø1.5, Ø1.8, Ø2.5, Ø3.0, Ø7.0
Special Perforation (mm)	Ø4.5, Ø12.0, 8x8 square (For detailed information on perforations pls. see pp. 41-45)
Standard Colours	RAL 9010 and RAL 9006 <ul style="list-style-type: none">• Production is possible in all other RAL Colours upon request.• Antibacterial paint option is available upon request, especially for areas with hygiene requirements.• Panels with wood appearance can be produced if requested. (For detailed information on Colours pls. see pp. 37-39)
Areas of Use	Renovation projects, offices, shopping centers, airports
Acoustics	NRC: 0.60 - 0.70 (For detailed information pls. see pp. 47-55)
Fire	Resistance to Fire class B-s1, d0 (For detailed information pls. see pp. 57-59)



LAY-IN FLAT

SYSTEM DETAIL

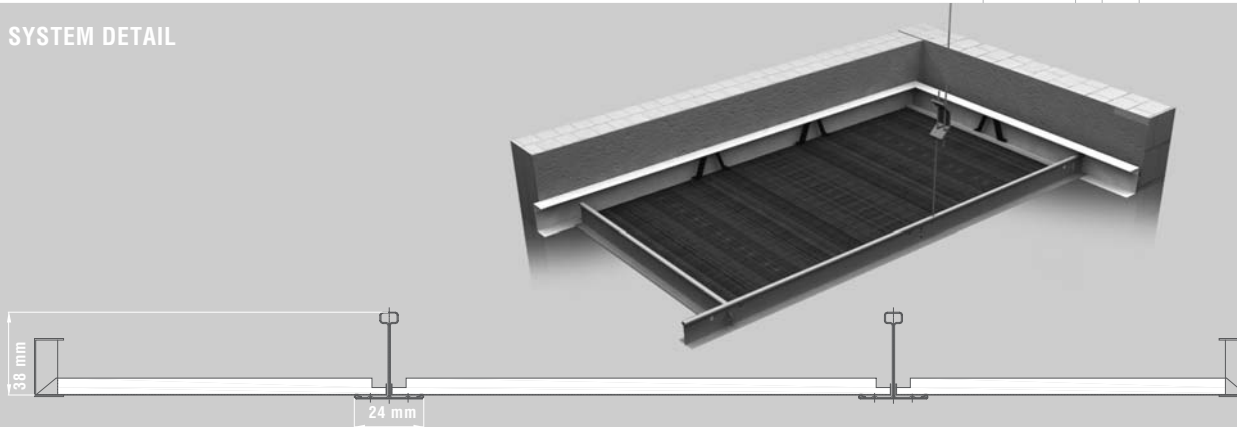

Accessories

01



52040101 AS-GR24-B01 T24 Main Runner-3600
Dimensions (mm) 24x38x3600x0,4
Packaging Details 90 m/carton
Weight 1,344 kg/pc

04



52010021 CDPR 310 C-Wall Angle
Dimensions (mm) 20x40x20x3000x0,5
Packaging Details 96 m/carton
Weight 0,326 kg/m

07



17010104 DST-01 Hanger Wire
Dimensions (mm) 1000
Packaging Details 500 pc/carton
Weight 0,10 kg/pc

02



52040102 AS-GR24-B02 T24 Cross Runner-1200
Dimensions (mm) 24x30x1200x0,4
Packaging Details 60 m/carton
Weight 0,3896 kg/pc

05



52010008 KT 40 Wedge Clip
Dimensions (mm)
Packaging Details 500 pc/carton
Weight 0,008 kg/pc

08



17020101 TP-02 Steel Anchor
Dimensions (mm)
Packaging Details 500 pc/carton
Weight 0,018 kg/pc

03



52040102 AS-GR24-B03 T24 Cross Runner-600
Dimensions (mm) 24x30x600x0,4
Packaging Details 45 m/carton
Weight 0,187 kg/pc

06



13011128 HDVC/4 Double Spring Clip
Dimensions (mm)
Packaging Details 500 pc/carton
Weight 0,0082 kg/pc

Accessories Joint Details

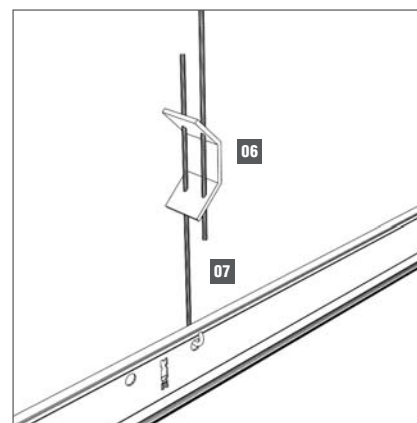
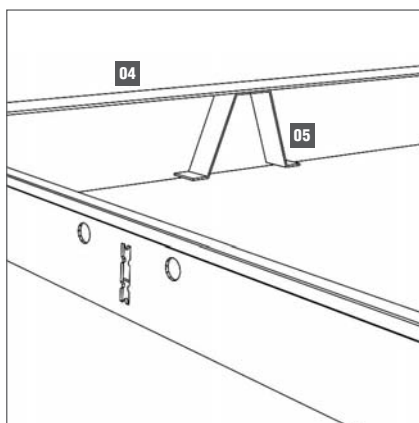
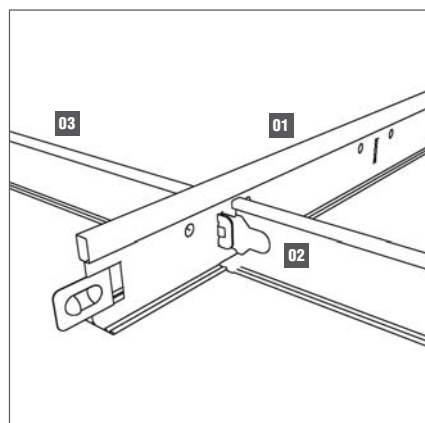

LAY-IN MICROLOOK

Integra Microlook Lay-in panels are fully compatible with various T-15 suspension profiles and are available in galvanized steel and aluminium. Microlook Lay-in panels create a narrower gap on the ceiling with the T-15 suspension profile and allow for a modern ceiling design. Integra Microlook Lay-in system offers the right solutions for offices, and shops in malls.





LAY-IN MICROLOOK

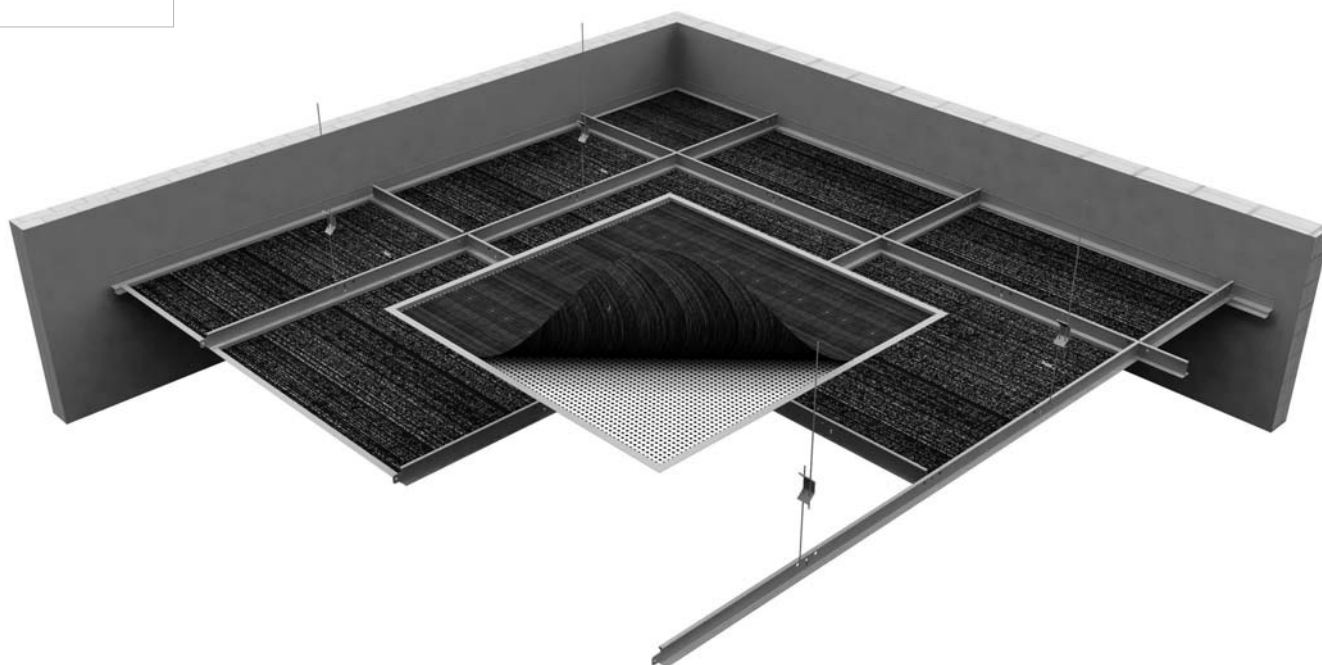

Material	Galvanized Steel, Aluminum
Dimensions	600x600 mm
Standard Perforation (mm)	Ø0.7, Ø1.5, Ø1.8, Ø2.5, Ø3.0, Ø7.0
Special Perforation (mm)	Ø4.5, Ø12.0, 8x8 square (For detailed information on perforations pls. see pp. 41-45)
Standard Colours	RAL 9010 and RAL 9006 <ul style="list-style-type: none">• Production is possible in all other RAL Colours upon request.• Antibacterial paint option is available upon request, especially for areas with hygiene requirements.• Panels with wood appearance can be produced if requested. (For detailed information on Colours pls. see pp. 37-39)
Areas of Use	Renovation projects, offices, shopping centers
Acoustics	NRC: 0.60 - 0.70 (For detailed information pls. see pp. 47-55)
Fire	Resistance to Fire class B-s1, d0 (For detailed information pls. see pp. 57-59)



LAY-IN MICROLOOK

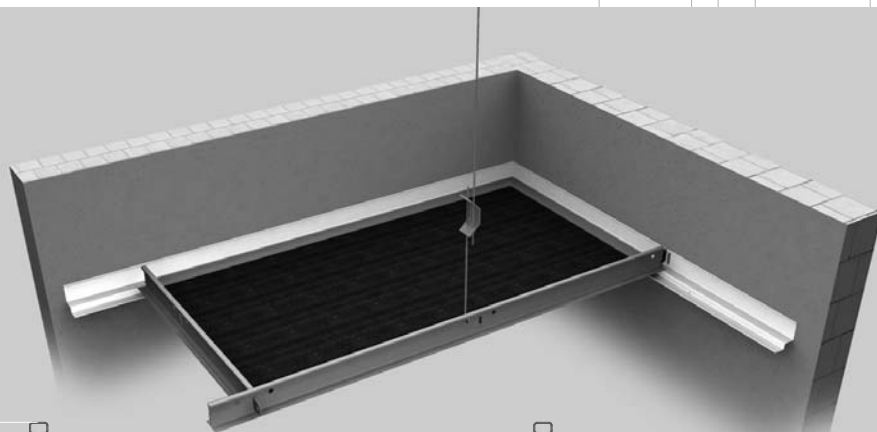

SYSTEM DETAIL

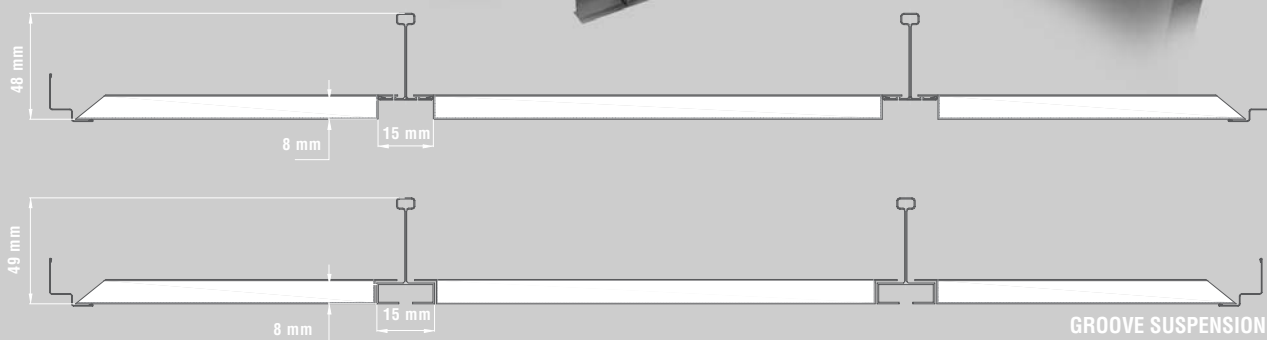

Accessories

01

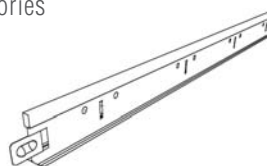

T15 Main Runner - 3600

Dimensions (mm) 15x38x3600x0,4
Packaging Details 90 m/carton
Weight 1,344 kg/pc

03



T15 Cross Runner - 600

Dimensions (mm) 15x30x600x0,4
Packaging Details 45 m/carton
Weight 0,187 kg/pc

05



13011128 HDVC/4 Double Spring Clip

Dimensions (mm)
Packaging Details 500 pc/carton
Weight 0,0082 kg/pc

02



T15 Cross Runner - 1200

Dimensions (mm) 15x30x1200x0,4
Packaging Details 60 m/carton
Weight 0,3896 kg/pc

04

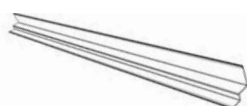

1508-B05 Z - Wall Angle

Dimensions (mm) 25x15x8x15x3050x0,5
Packaging Details 106,75 m/carton
Weight 0,79 kg/pc

06



17010104 DST-01 Hanger Wire

Dimensions (mm) 1000
Packaging Details 500 pc/carton
Weight 0,10 kg/pc

Accessories Joint Details

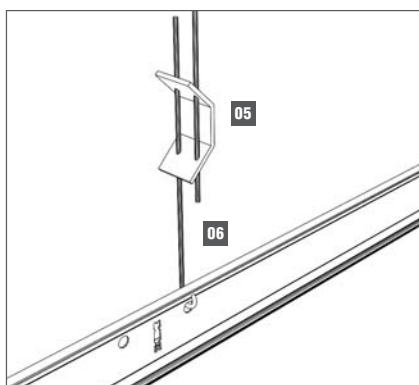
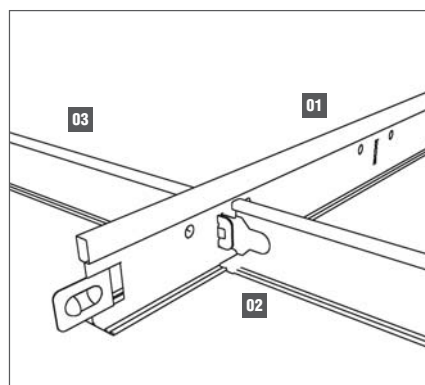

07



17020101 TP-02 Steel Anchor

Dimensions (mm)
Packaging Details 500 pc/carton
Weight 0,018 kg/pc



WALL JOINT DETAILS

C-WALL ANGLE CDPR 310

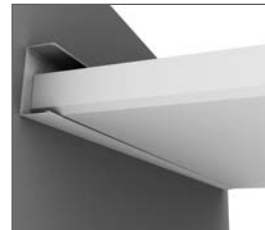
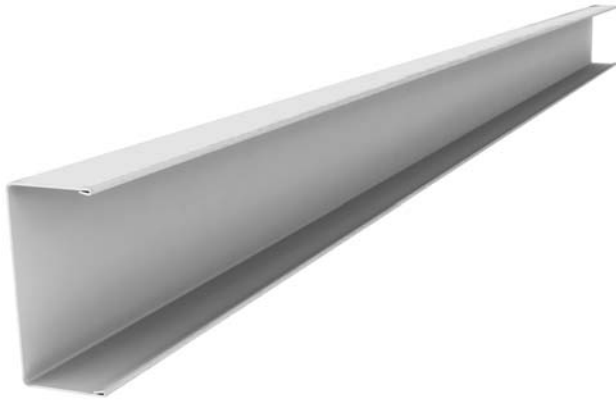

Bottom View

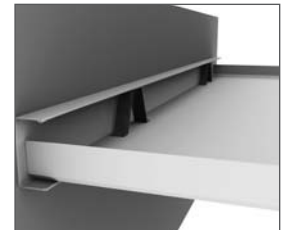

Cut Plate Finish

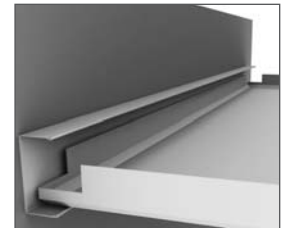

Full Plate Finish

Packaging Details

Dimensions (mm)	20x40x20
Length (mm)	3000
Weight (kg/pc)	0.98
m/packaging	96.00

L- WALL ANGLE WL 3000

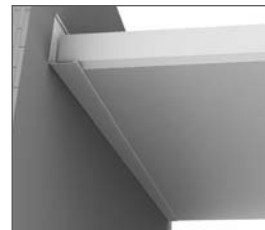

Bottom View



Cut Plate Finish

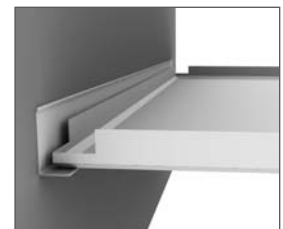

Full Plate Finish

Packaging Details

Dimensions (mm)	20x40
Length (mm)	3000
Weight (kg/pc)	0.95
m/packaging	60.00

GRIDA L AS-GR1919-B04

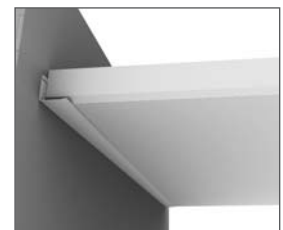

Bottom View

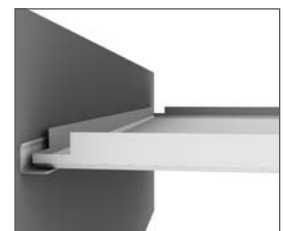

Full Plate Finish

Packaging Details

Dimensions (mm)	19x19
Length (mm)	3050
Weight (kg/pc)	0.50
m/packaging	137.25



WALL JOINT DETAILS

Z PROFILE WITH FOLDING TABS BTZ - 300



Packaging Details

Dimensions (mm)	24x15x10x20
Length (mm)	3000
Weight (kg/pc)	0.93
m/packaging	105.00

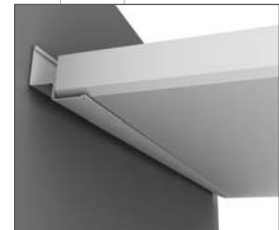

Bottom View

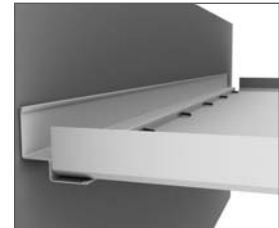

Cut Plate Finish

SHADOW ANGLE AS-GR1508-B05



Packaging Details

Dimensions (mm)	25x15x8x15
Length (mm)	3050
Weight (kg/pc)	0.79
m/packaging	106.75



Bottom View



Full Plate Finish

HALF CLIP-IN PROFILE HCLN-400



Packaging Details

Dimensions (mm)	18x29
Length (mm)	4000
Weight (kg/pc)	0.35
m/packaging	80.00

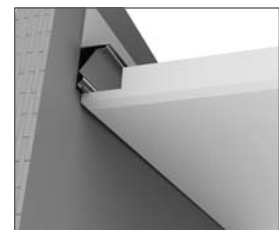

Bottom View



Full Plate Finish



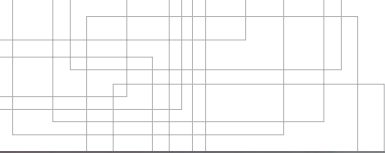



INTEGRATION and LIGHTING

Integra Metal Ceilings can be integrated with various lighting, ventilation, heating and sprinkler systems. Custom-made cutting and bending can be carried out for lighting fixtures and ventilation inlets while special designs compatible with system details can also be produced on demand.

INTEGRATION AND LIGHTING

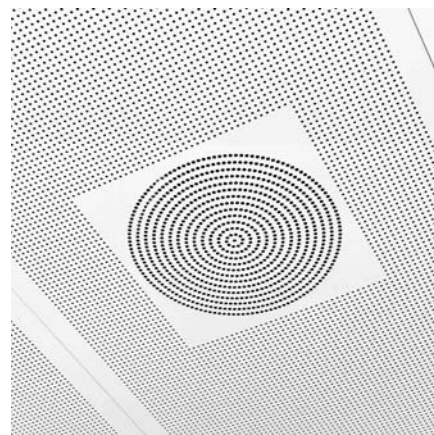
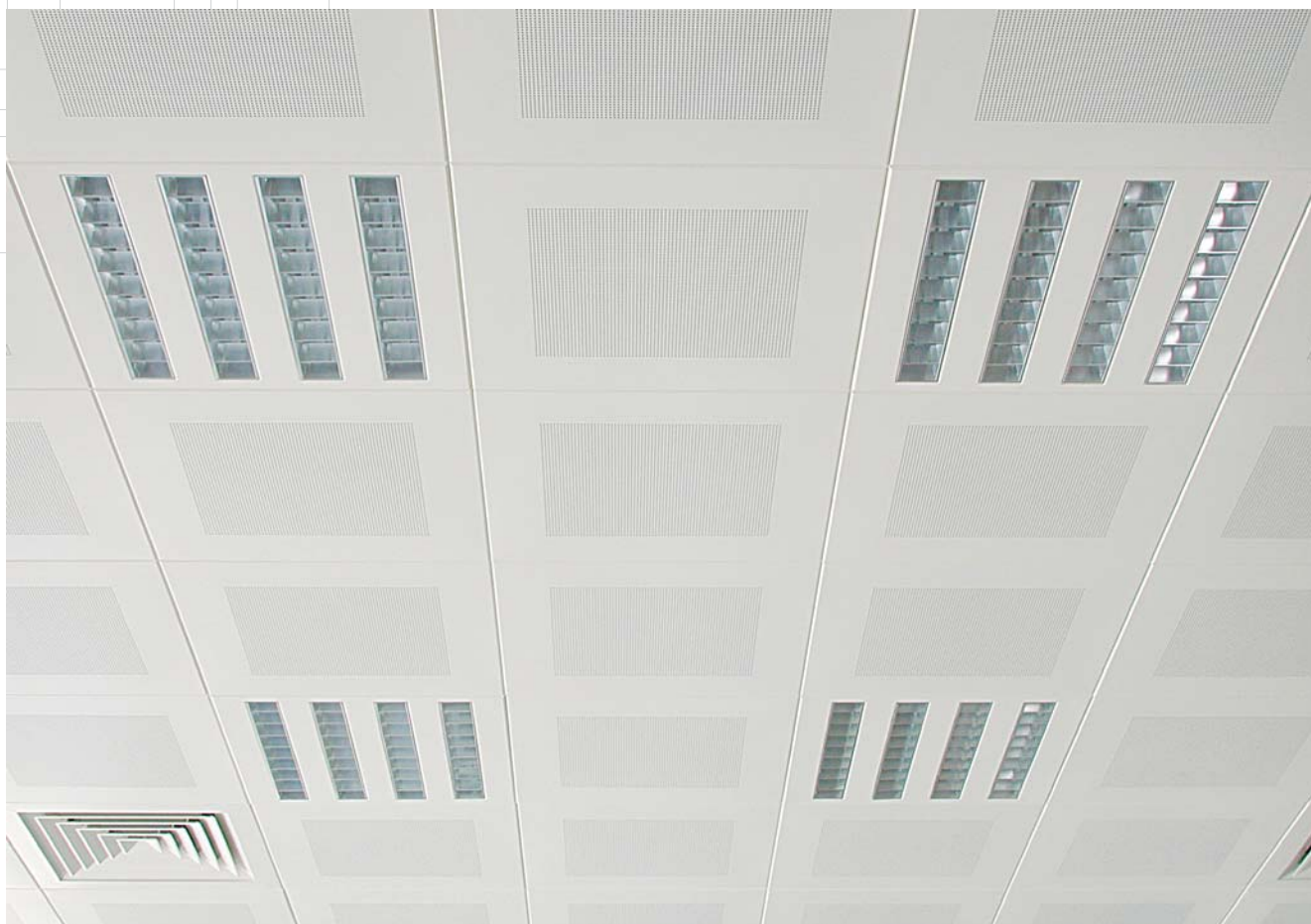

All elements produced for lighting fixtures and ventilation inlets of various sizes are coated with electrostatic powder paint after perforation, cutting and bending. This provides full protection against the effects of outside agents on the surface.



INTEGRATION AND LIGHTING



MODUS DP. MIR. REFL. PERFORATED



MODUS DP. MIR. REFL. WITHOUT PERFORATION



MODUS PC LAMEL WITHOUT PERFORATION

MODUS

Modus is used in spaces where a high lighting technique and energy saving solutions are needed.

DP. MIR. REFL.

The reflector which provides glare control is produced from highly reflective aluminum and is double parabolic.

PC LAMEL

The fixture which emits direct light, illuminates the environment through polycarbonate lamella.

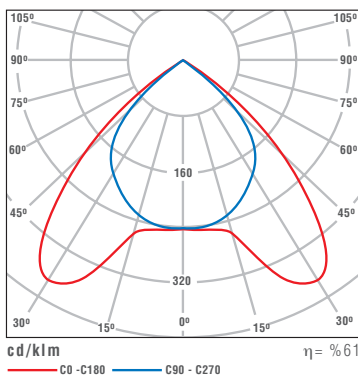

Light Technique Characteristics

: Direct
: The fixture body is produced from steel sheets.
Coated with highly reflective electrostatic powder coating

Light Source

: T5 4x14W, 3x14W, 4x24W, 3x24W

Ballast

: Electronic Ballast (Hot ignition)

Electrical Protection

: Class I, IP 20

Installation

: The fixture is integrated into the metal ceiling plate.



QUADUS

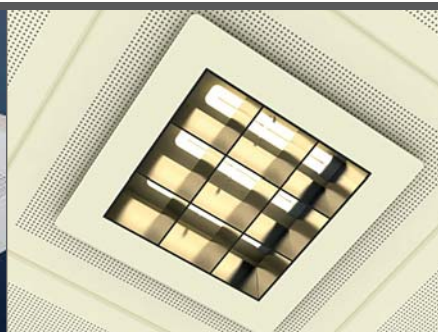

QUADUS SR REFL

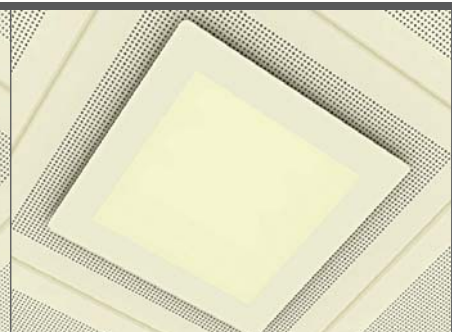

QUADUS OPAL DIFFUSER

QUADUS

Quadus is the fixture for all spaces where the lighting technique and energy efficiency are important.

DEPTH MATTE REFLECTOR

The reflector which provides high glare control is produced from highly reflective, 0.4 mm thick, 9 celled satin-matt aluminum and is double parabolic.

OPAL DIFFUSER

The fixture which emits direct light emits the illuminates into the environment with an opal diffuser. The opal diffuser is acrylic PMMA.

Light Technique

: Direct

Light Source

: TC-L 3X18W, 3X24W

Ballast

: Electronic Ballast (Hot Ignition)

Electrical Protection

: Class I, IP 20

Installation

: The fixture is integrated into the metal ceiling plate.

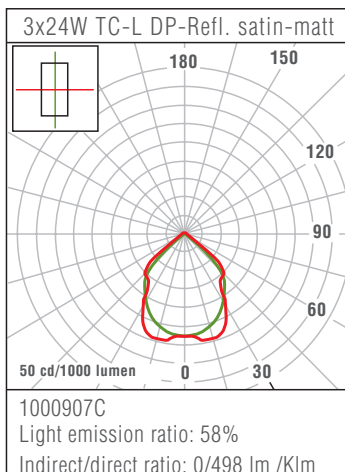

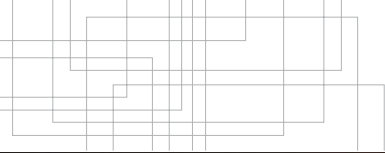



COLOUR AND PATTERN

Integra Metal Ceiling Systems offer a broad selection of colours to support the imagination of designers. In addition to the standard RAL colours on Integra's colour card, the panels can be produced in all RAL colours or with wood appearance upon request. An anti-bacterial paint option is also available for use in areas where hygiene is important.

COLOURS

RAL COLOURS



RAL 9010



RAL 9002

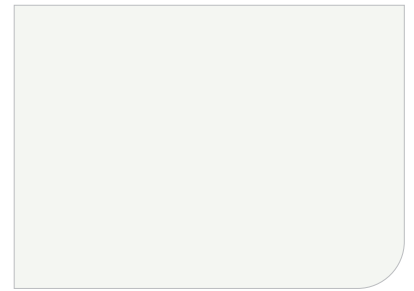

RAL 9016

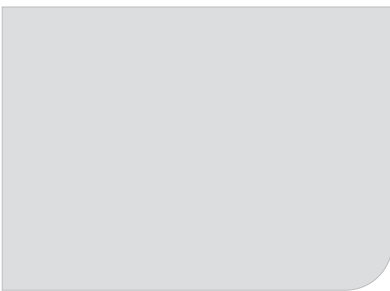

RAL 7047



RAL 7004

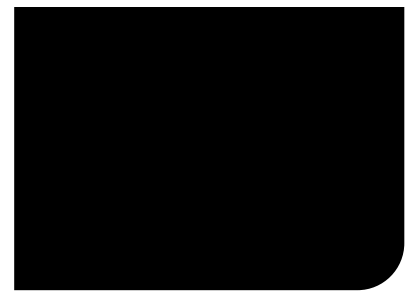

RAL 9005



RAL 2008



RAL 1018



RAL 6002

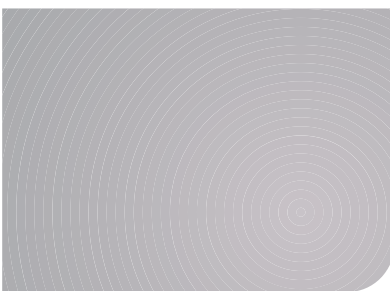

RAL 9006 METALLIC



RAL 9022 METALLIC



RAL 9007 METALLIC

OPTIONS FOR WOOD APPEARANCE



101-V13 Walnut-1



104-V1 Walnut-2



100-V1 Acacia

For other colour and wood patterns, please contact Integra head office.



COLOURS

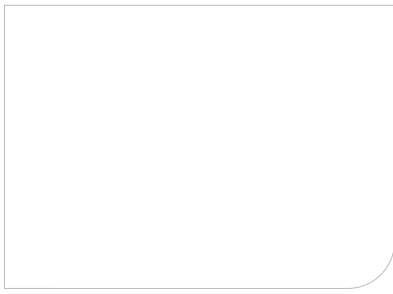

RAL 9003

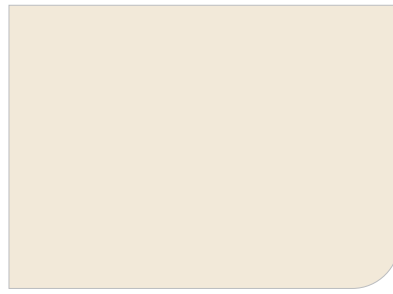

RAL 1013



RAL 7035



RAL 8011



RAL 3005



RAL 3020



RAL 5012



RAL 1035 METALLIC



RAL 7048 METALLIC



108-V3 Oak-1



103-V7 Oak-2

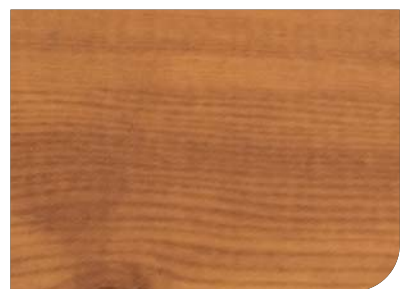

102-V1 Pine



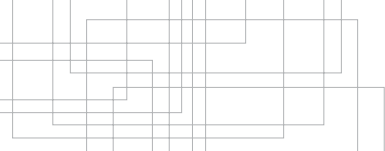



PERFORATION

All products are offered in plain or perforated form (0.7mm, 1.5mm, 1.8mm, 2.5mm, 3.0mm, 7.0mm). All perforated products can be produced with various plain borders upon request. Special perforated products may be available on request.

PERFORATION

STANDARD PERFORATIONS

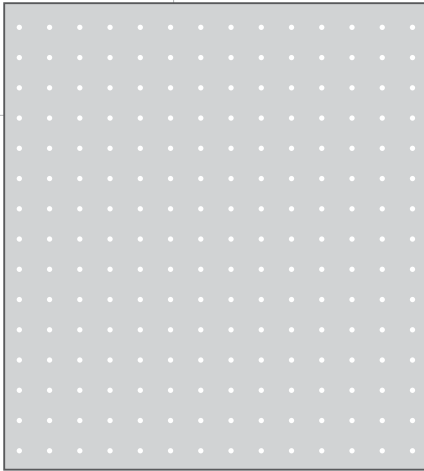

**Perforation
Open Area**

Ø0,7 mm
%2,4

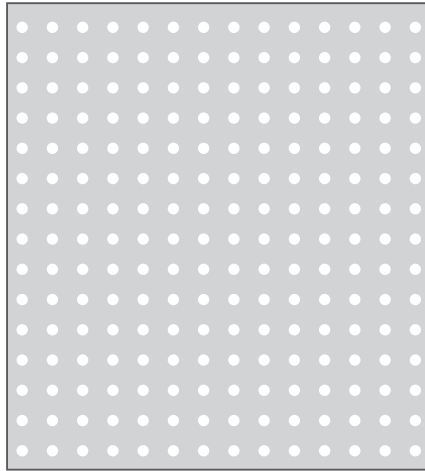

**Perforation
Open Area**

Ø1,5 mm
%11

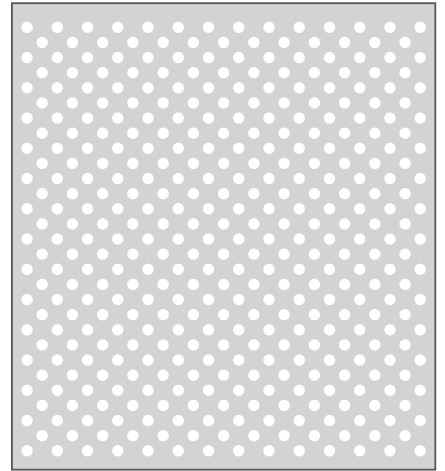

**Perforation
Open Area**

Ø1,5 mm
%22

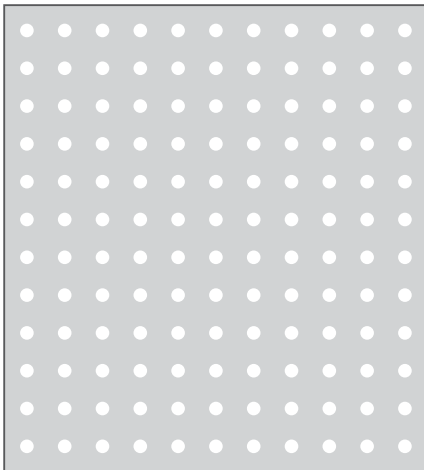

**Perforation
Open Area**

Ø1,8 mm
%10,5

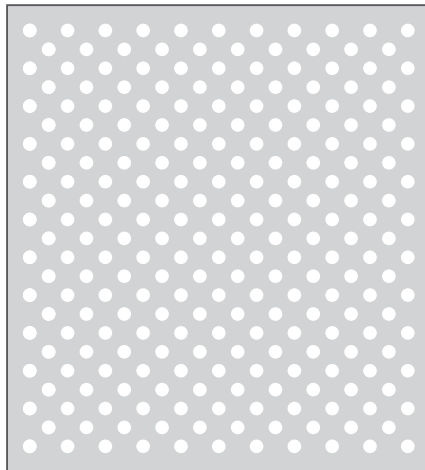

**Perforation
Open Area**

Ø1,8 mm
%21

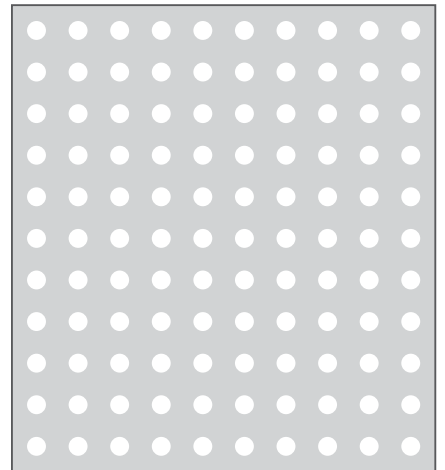

**Perforation
Open Area**

Ø2,5 mm
%16

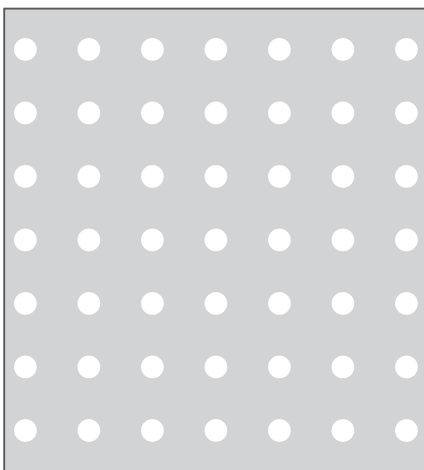

**Perforation
Open Area**

Ø3 mm
%10

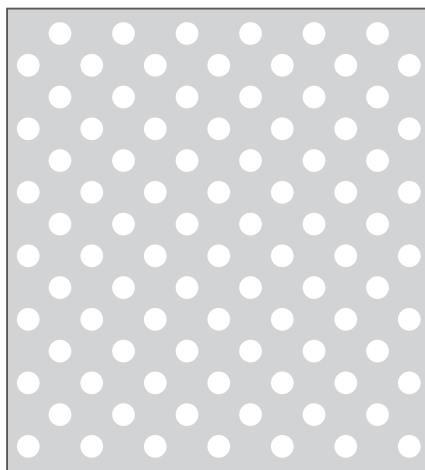

**Perforation
Open Area**

Ø3 mm
%20

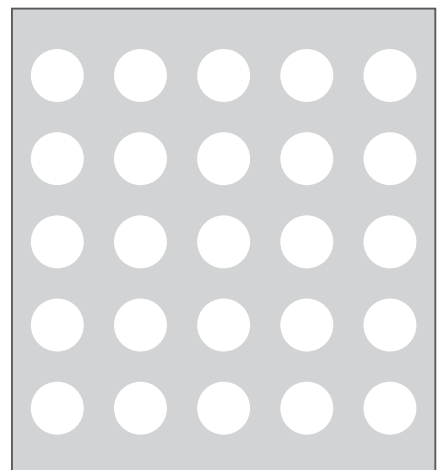

**Perforation
Open Area**

Ø7 mm
%32



PERFORATION

SPECIAL PERFORATIONS

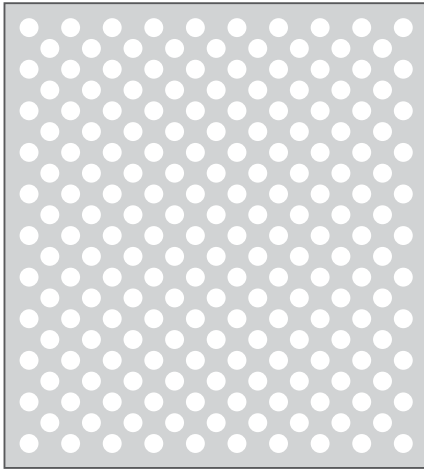

**Perforation
Open Area**

Ø2.5 mm
%32

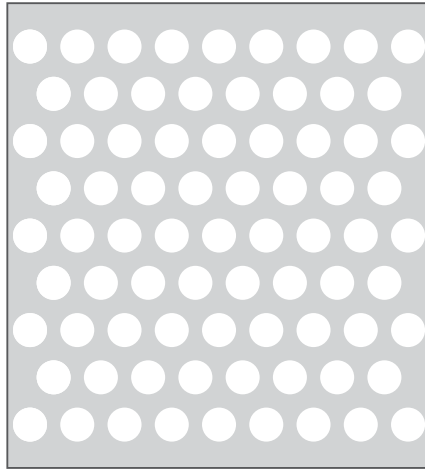

**Perforation
Open Area**

Ø4,5 mm
%41

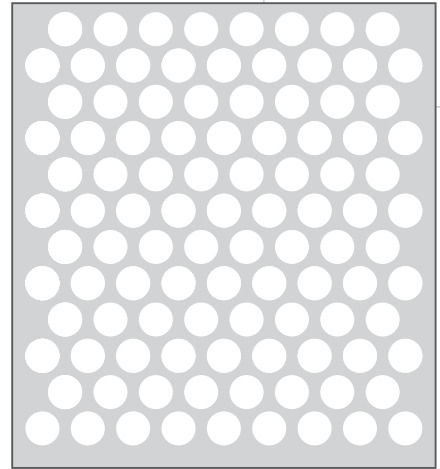

**Perforation
Open Area**

Ø4,5 mm
%55

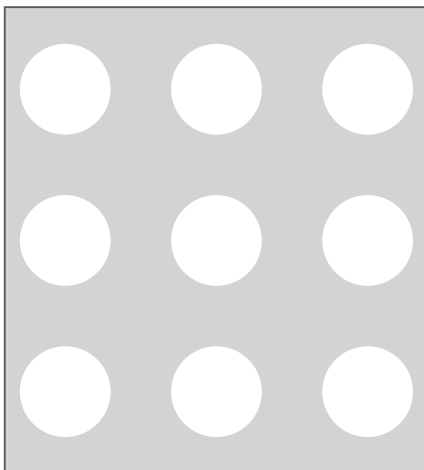

**Perforation
Open Area**

Ø12 mm
%28

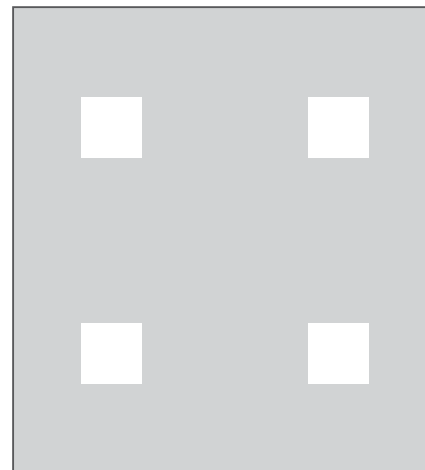

**Perforation
Open Area**

8x8 mm
%7

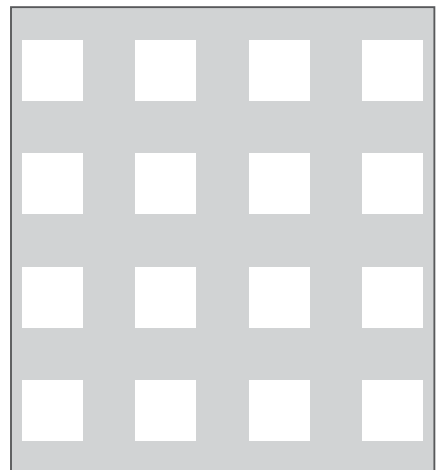

**Perforation
Open Area**

8x8 mm
%28

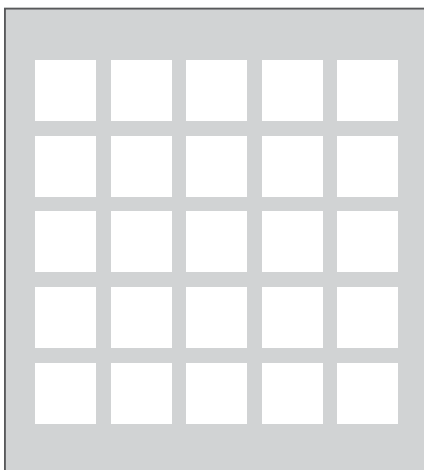



**Perforation
Open Area**

8x8 mm
%64

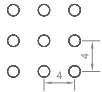
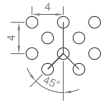
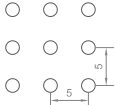
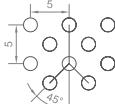

PERFORATION

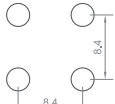
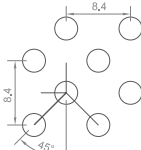
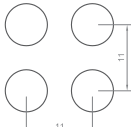
STANDARD PERFORATIONS	Perforation Diameter (mm)	Open Area (%)	Alignment Form	Max. Perforation Width (mm)	Max. Roll Width (mm)	Max. Material Thickness Steel (mm)	Max. Material Thickness Alu. (mm)	Sound Absorption (Soundtex)		Sound Absorption (Soundtex + Rockwool)	
								NRC	α_w	NRC	α_w
	Ø0,7	%2.4	Square	697	750	0.6	0.7	0.60	0.60	0.70	0.60
	Ø1.5	%11.0	Square	1236	1305	0.7	0.7	0.70	0.75	0.85	0.85
	Ø1.5	%22.0	Diagonal	1238	1305	0.7	0.7	0.60	0.60	0.85	0.90
	Ø1.8	%10.5	Square	1255	1305	0.7	1.0	0.70	0.75	0.80	0.85
	Ø1.8	%21.0	Diagonal	1258	1305	0.7	1.0	0.60	0.60	0.85	0.90
	Ø2.5	%16.0	Square	1260	1305	1.0	1.0	0.70	0.70	0.80	0.85
	Ø3.0	%10.0	Square	697	1250	0.7	0.7				
	Ø3.0	%20.0	Diagonal	701	1250	0.7	0.7	0.65	0.65	0.85	0.90
	Ø7.0	%32.0	Square	715	1250	1.0	1.0	0.70	0.75	0.85	0.85

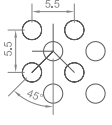
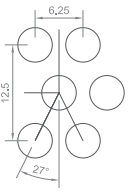
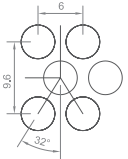
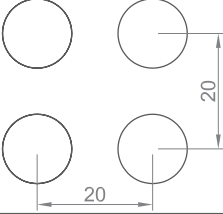
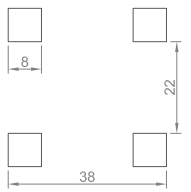
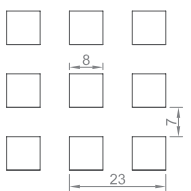
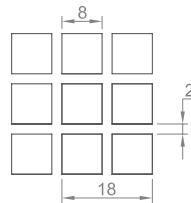

PERFORATION

SPECIAL PERFORATIONS	Perforation Diameter (mm)	Open Area (%)	Alignment Form	Max. Perforation Width (mm)	Max. Roll Width (mm)	Max. Material Thickness Steel (mm)	Max. Material Thickness Alu. (mm)	Sound Absorption (Soundtex)		Sound Absorption (Soundtex + Rockwool)	
								NRC	α_w	NRC	α_w
	Ø2.5	%32.0	Diagonal	1270	1300	0.7	1.0	0.60	0.65	0.90	0.90
	Ø4.5	%41.0	Diagonal	1270	1300	0.7	1.0				
	Ø4.5	%55.0	Diagonal	1270	1300	0.7	1.0	0.60	0.60	0.85	0.90
	Ø12.0	%28.0	Square	1270	1300	0.7	1.0	0.75	0.75	0.80	0.85
	8x8	%7.0	Square	1270	1300	0.7	1.0				
	8x8	% 28.0	Square	1270	1300	0.7	1.0	0.75	0.75		
	8x8	%64.0	Square	1270	1300	0.7	1.0				



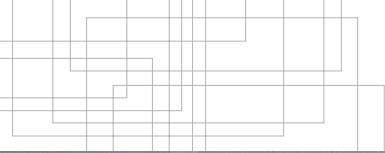



ACOUSTICS

Integra panels are manufactured with acoustic inlay to provide the best acoustic solutions. Special acoustic infill materials can be adapted for particular acoustic requirements.

ACOUSTICS

Building acoustics can be reviewed under 3 main titles.

Indoor acoustics:

Associated with providing acoustic properties in enclosed spaces. While the most important evaluation criterion is reverberation time, "sound absorption" in the space is the key to achieving the acoustic values desired.

Sound insulation:

Associated with the feature of building and building conditions to prevent sound passing between two rooms. It can be divided into 2 types; providing sound insulation by air way and impact sound insulation in adjacent areas.

Noise:

Associated with sounds in the outside environment such as vehicle noise, air conditioner, lighting equipment and background sounds or the human voice coming from the adjoining room.

SOUND ABSORPTION;

When a sound wave hits any surface, part of its energy is reflected back into the room while the other part of it affects the surface. Part of the sound wave energy is converted into thermal energy and is absorbed while the remaining part is transmitted. The level of the energy converted into thermal energy is dependent on the sound absorption capacity of the panel.

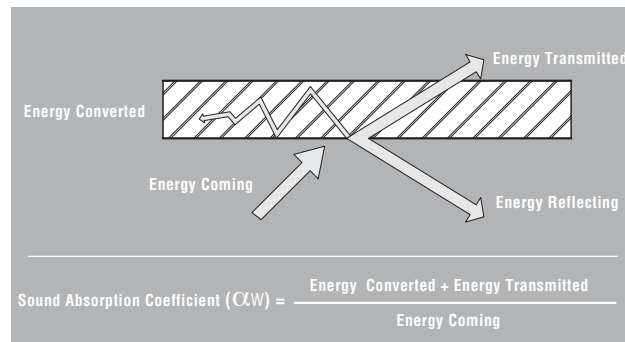

Integra metal ceiling panels to having been subjected tests in international institutes and laboratories in accordance with DIN EN 20354 and DIN EN ISO 116554 norms and meet the sound absorption values (NRC) required in the space.

Sound absorption values are related directly to the material used and perforations applied on the panel. Perforated Metal Ceilings improve room acoustics and reduce the echo time.

SOUND INSULATION

Sound insulation is applied in order to; protect against the hazardous effects of noise by insulating the living environment from undesired sounds, to reduce the sounds emitted from noisy areas in the environment into the surrounding area and to create suitable conditions of use in spaces such as movie theaters and recording studios. Sound reduction values are generally subjected to testing according to EN ISO 140 and EN ISO 717-1 norms in the 1/3 octave band. The sound reduction value for acoustic applications in buildings is tested at frequencies ranging from 100 to 3150 Hz as per ISO and from 125 to 4000 Hz as per ASTM. The sound insulation value for ceilings according to the EN ISO 717-1 norms is defined as $D_{n,c,w}$ (dB). INTEGRA metal ceiling panels sound insulation values are able to decrease sound transmissions arising from sound sources such as ventilation in the ceiling void, lighting systems and noise transmitted from room to room. (20-40 dB)

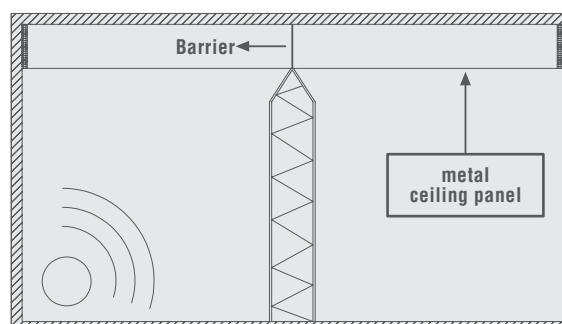

ACOUSTICS

Size : 600x600x0.6 mm
 Perforation Type : **Ø0.7** mm, Square
 Open Area : **2.4%**
 Acoustical Inlay : **Soundtex**

Volume of reverberation room : 214 m³
 Sample area : 10,87 m²
 System height : 0.2 m
 Signal : Broad band
 Band-width : 1/3 octave

α_w (ISO 11654) = **0,60**

NRC (ASTM - C 423) = **0,60**

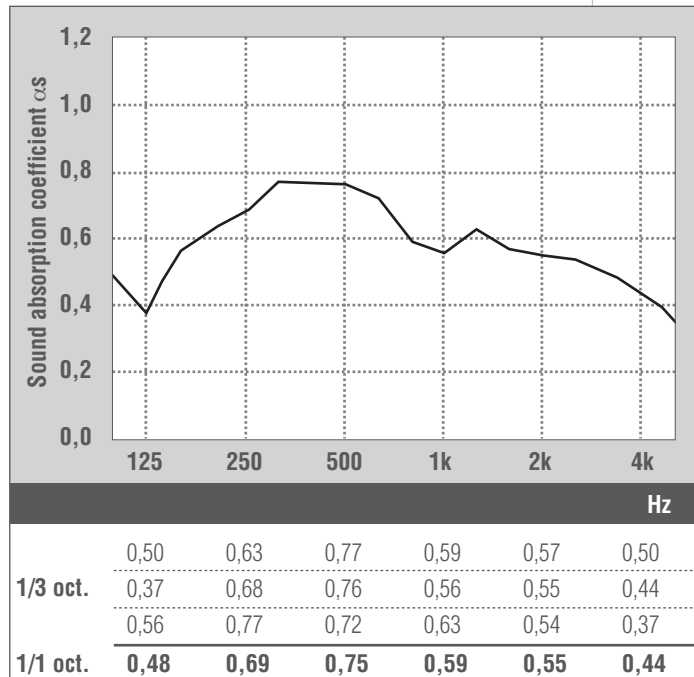

Size : 600x600x0.6 mm
 Perforation Type : **Ø0.7** mm, Square
 Open Area : **2.4%**
 Acoustical Inlay : **Soundtex + 25 mm x 18.7 kg/m³ glasswool**

Volume of reverberation room : 214 m³
 Sample area : 10,87 m²
 System height : 0.2 m
 Signal : Broad band
 Band-width : 1/3 octave

α_w (ISO 11654) = **0,60**

NRC (ASTM - C 423) = **0,70**

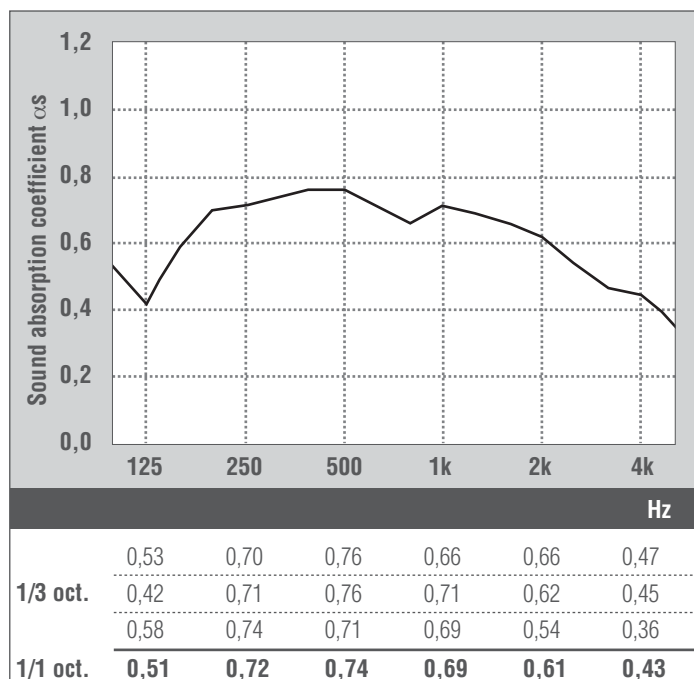

ACOUSTICS

Size : 600x600x0.6 mm
 Perforation Type : **Ø1.5** mm, Square
 Open Area : **22%**
 Acoustical Inlay : **Soundtex**

Volume of reverberation room : 214 m³
 Sample area : 10,87 m²
 System height : 0.2 m
 Signal : Broad band
 Band-width : 1/3 octave

α_w (ISO 11654) = **0,60**

NRC (ASTM - C 423) = **0,60**

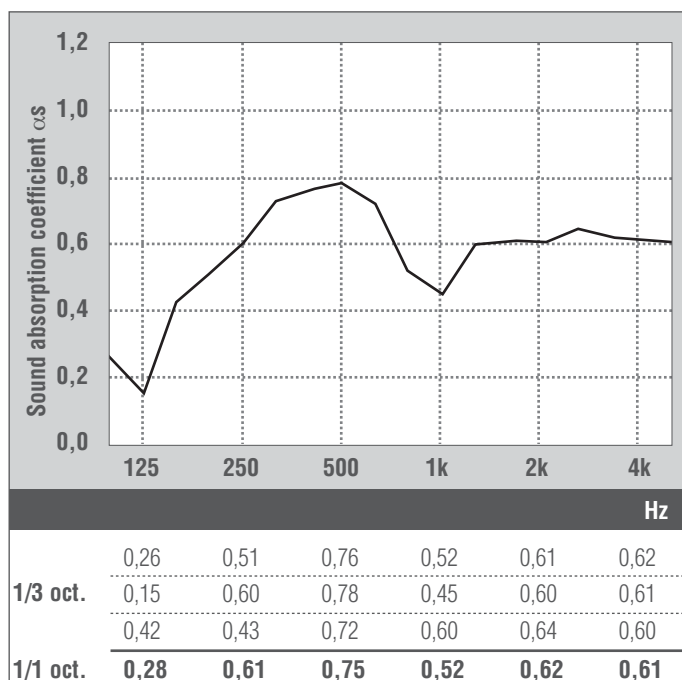

Size : 600x600x0.6 mm
 Perforation Type : **Ø1.5** mm, Square
 Open Area : **22%**
 Acoustical Inlay : **Soundtex + 25 mm x 50 kg/m³ rockwool**

Volume of reverberation room : 214 m³
 Sample area : 10,87 m²
 System height : 0.2 m
 Signal : Broad band
 Band-width : 1/3 octave

α_w (ISO 11654) = **0,90**

NRC (ASTM - C 423) = **0,85**

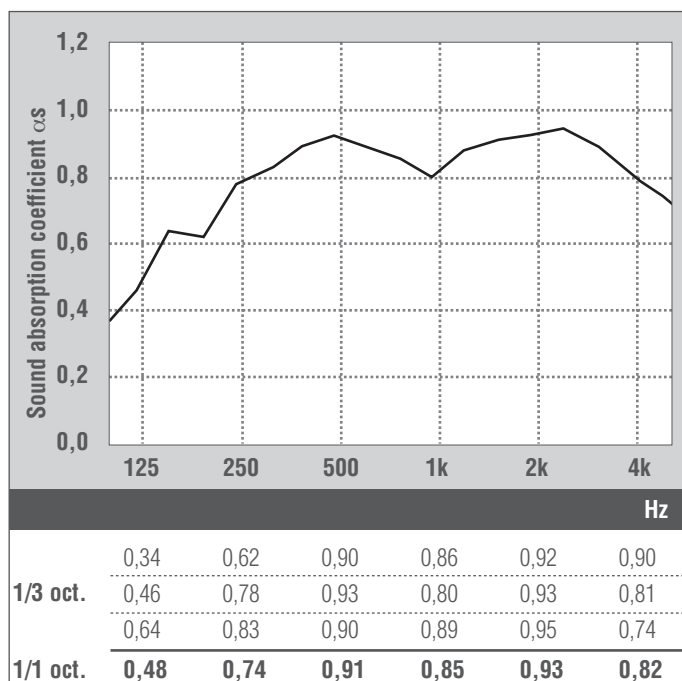

ACOUSTICS

Size : 600x600x0.6 mm
 Perforation Type : **Ø1.8** mm, Square
 Open Area : **21%**
 Acoustical Inlay : **Soundtex**

Volume of reverberation room : 214 m³
 Sample area : 10,87 m²
 System height : 0.2 m
 Signal : Broad band
 Band-width : 1/3 octave

α_w (ISO 11654) = **0,60**

NRC (ASTM - C 423) = **0,60**

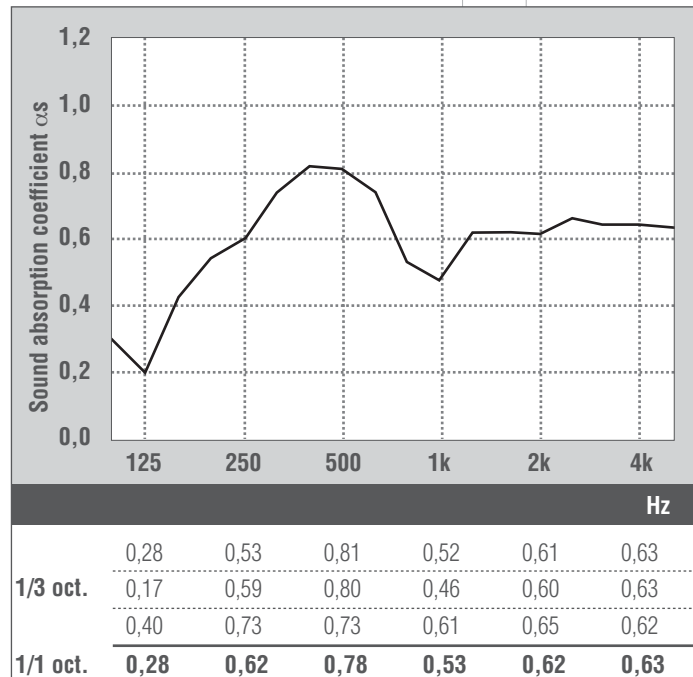

Size : 600x600x0.6 mm
 Perforation Type : **Ø1.8** mm, Square
 Open Area : **21%**
 Acoustical Inlay : **Soundtex + 25 mm x 50 kg/m³ rockwool**

Volume of reverberation room : 214 m³
 Sample area : 10,87 m²
 System height : 0.2 m
 Signal : Broad band
 Band-width : 1/3 octave

α_w (ISO 11654) = **0,90**

NRC (ASTM - C 423) = **0,85**

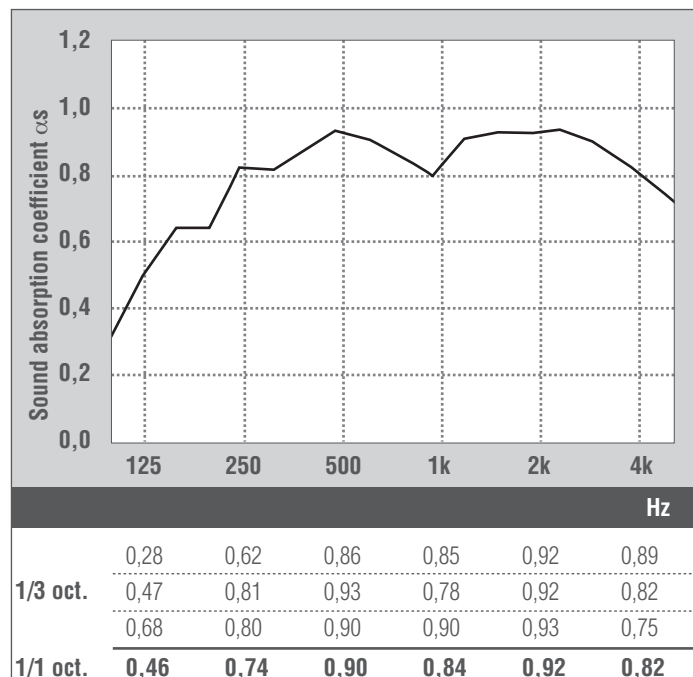

ACOUSTICS

Size : 600x600x0.6 mm
 Perforation Type : **Ø2.5** mm, Square
 Open Area : **16%**
 Acoustical Inlay : **Soundtex**

Volume of reverberation room : 214 m³
 Sample area : 10,87 m²
 System height : 0.2 m
 Signal : Broad band
 Band-width : 1/3 octave

α_w (ISO 11654) = **0,70**

NRC (ASTM - C 423) = **0,70**

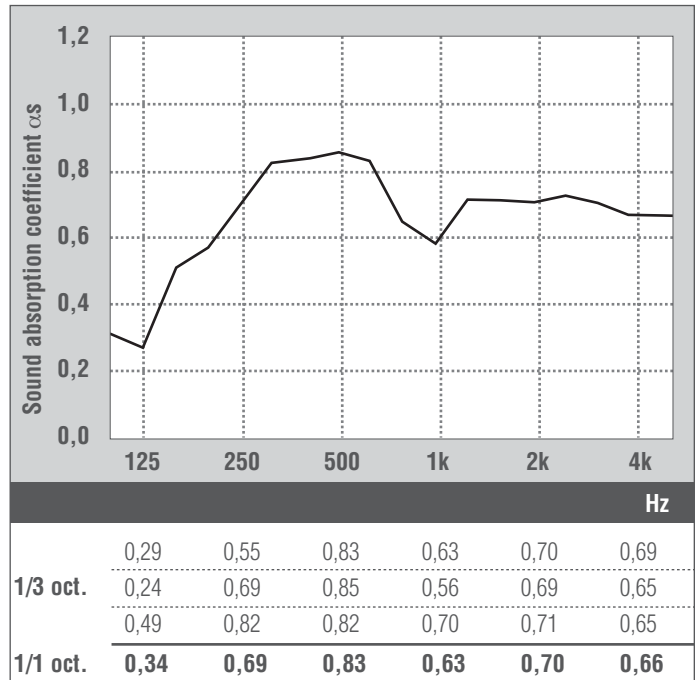

Size : 600x600x0.6 mm
 Perforation Type : **Ø2.5** mm, Square
 Open Area : **16%**
 Acoustical Inlay : **Soundtex + 25 mm x 50 kg/m³ rockwool**

Volume of reverberation room : 214 m³
 Sample area : 10,87 m²
 System height : 0.2 m
 Signal : Broad band
 Band-width : 1/3 octave

α_w (ISO 11654) = **0,85**

NRC (ASTM - C 423) = **0,80**

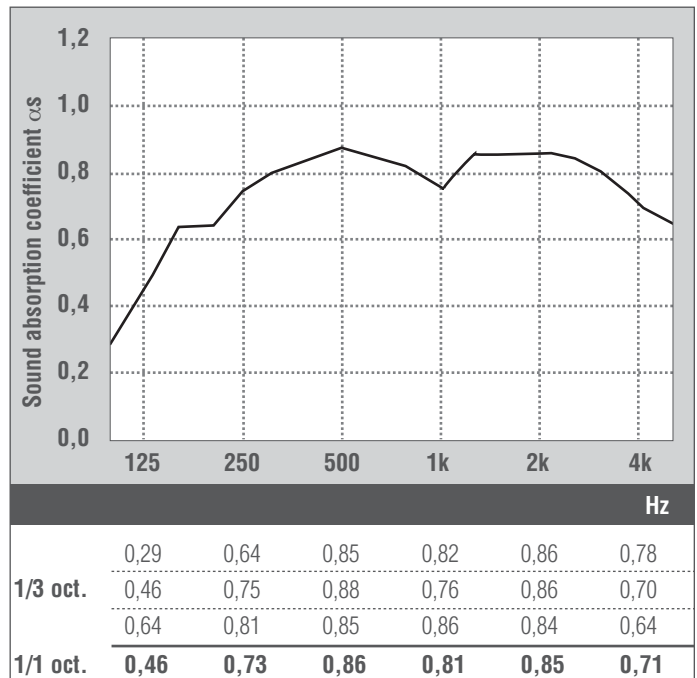

ACOUSTICS

Size : 600x600x0.6 mm
 Perforation Type : **Ø3** mm, Square
 Open Area : **20%**
 Acoustical Inlay : **Soundtex**

Volume of reverberation room : 214 m³
 Sample area : 10,87 m²
 System height : 0.2 m
 Signal : Broad band
 Band-width : 1/3 octave

α_w (ISO 11654) = **0,65**

NRC (ASTM - C 423) = **0,65**

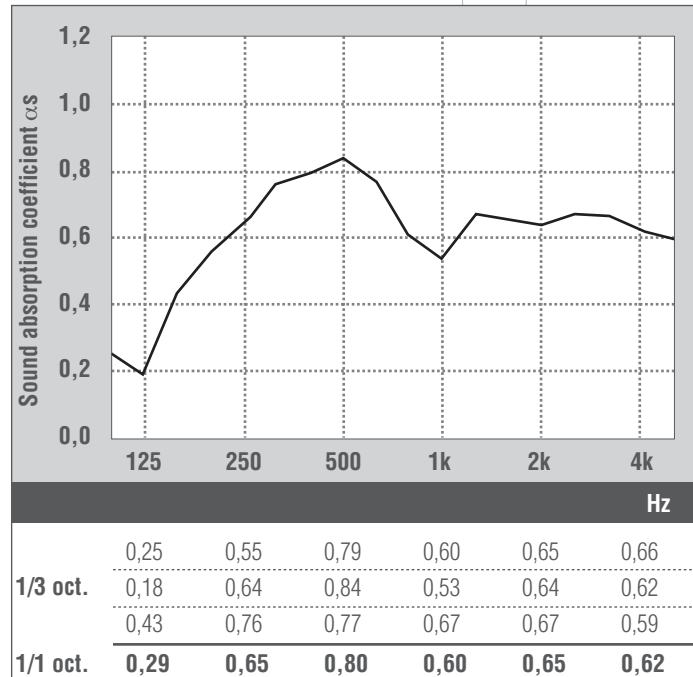

Size : 600x600x0.6 mm
 Perforation Type : **Ø3** mm, Square
 Open Area : **20%**
 Acoustical Inlay : **Soundtex + 25 mm x 50 kg/m³ rockwool**

Volume of reverberation room : 214 m³
 Sample area : 10,87 m²
 System height : 0.2 m
 Signal : Broad band
 Band-width : 1/3 octave

α_w (ISO 11654) = **0,90**

NRC (ASTM - C 423) = **0,85**

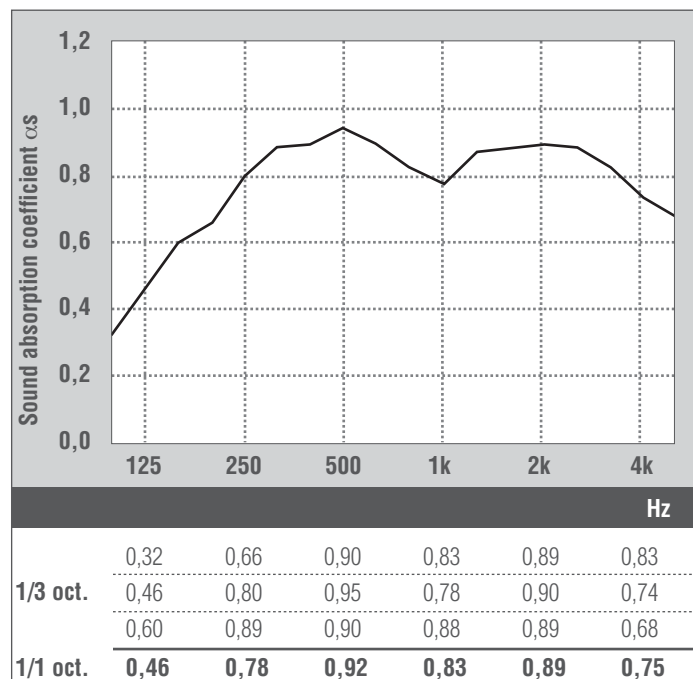

ACOUSTICS

Size : 600x600x0.6 mm
 Perforation Type : **Ø7** mm, Square
 Open Area : **32%**
 Acoustical Inlay : **Soundtex**

Volume of reverberation room : 214 m³
 Sample area : 10,87 m²
 System height : 0.2 m
 Signal : Broad band
 Band-width : 1/3 octave

α_w (ISO 11654) = **0,75**
 NRC (ASTM - C 423) = **0,70**

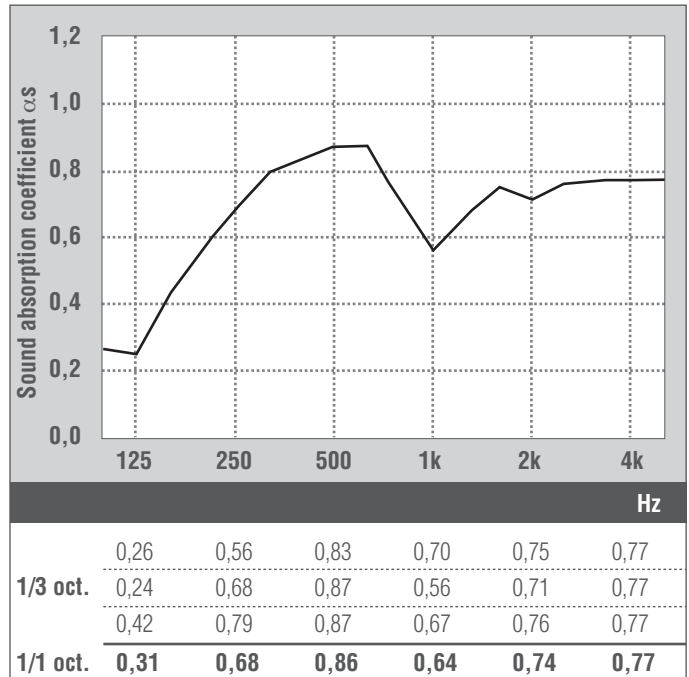

Size : 600x600x0.6 mm
 Perforation Type : **Ø7** mm, Square
 Open Area : **32%**
 Acoustical Inlay : **Soundtex + 25 mm x 18.7 kg/m³ glasswool**

Volume of reverberation room : 214 m³
 Sample area : 10,87 m²
 System height : 0.2 m
 Signal : Broad band
 Band-width : 1/3 octave

α_w (ISO 11654) = **0,85**
 NRC (ASTM - C 423) = **0,85**

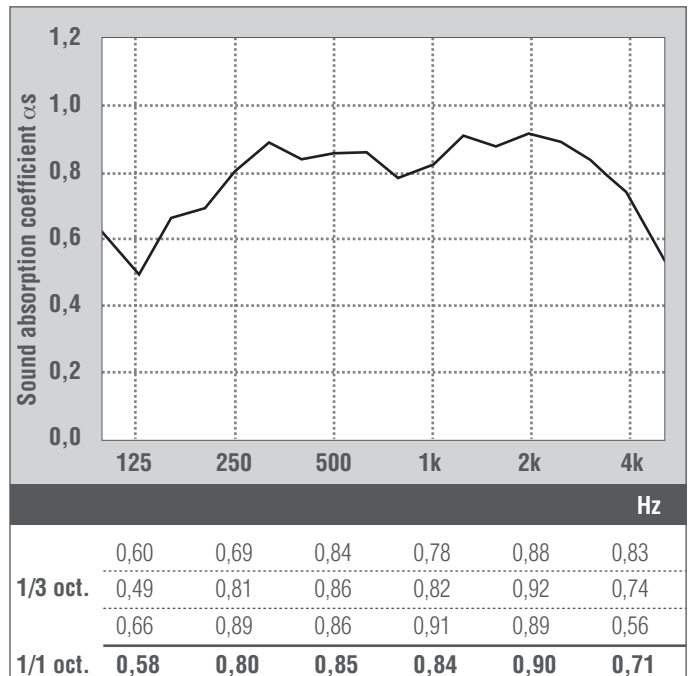

ACOUSTICS

Size : 600x600x0.6 mm
 Perforation Type : **Ø12** mm, Square
 Open Area : **28%**
 Acoustical Inlay : **Soundtex**

Volume of reverberation room : 214 m³
 Sample area : 10,87 m²
 System height : 0.2 m
 Signal : Broad band
 Band-width : 1/3 octave

α_w (ISO 11654) = **0,75**

NRC (ASTM - C 423) = **0,75**

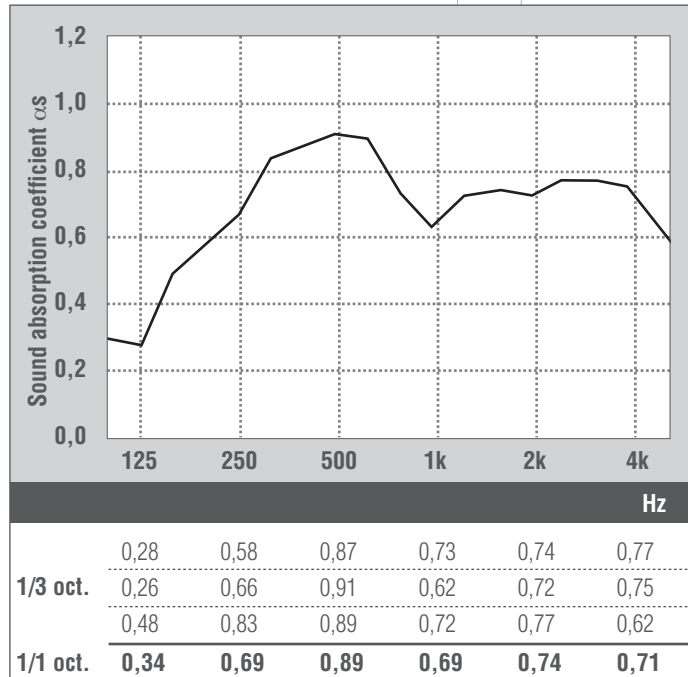

Size : 600x600x0.6 mm
 Perforation Type : **Ø12** mm, Square
 Open Area : **28%**
 Acoustical Inlay : **Soundtex + 25 mm x 18.7 kg/m³ glasswool**

Volume of reverberation room : 214 m³
 Sample area : 10,87 m²
 System height : 0.2 m
 Signal : Broad band
 Band-width : 1/3 octave

α_w (ISO 11654) = **0,85**

NRC (ASTM - C 423) = **0,80**

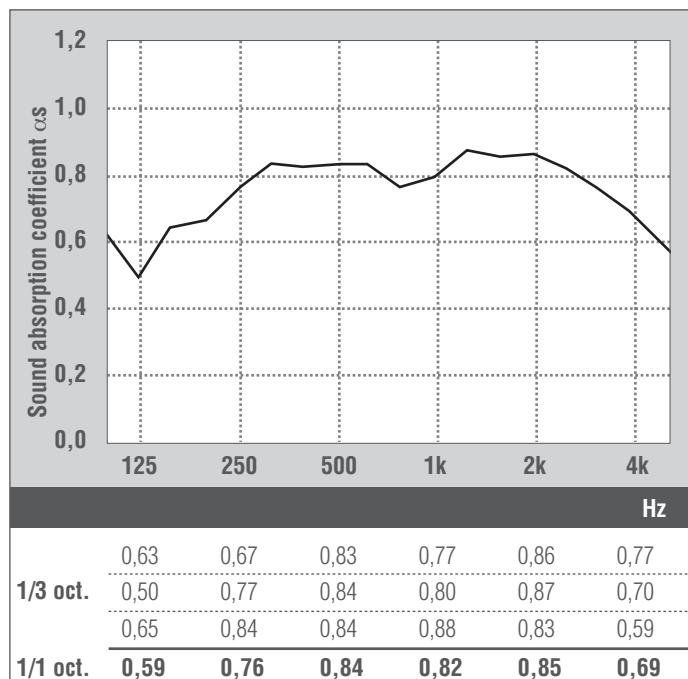

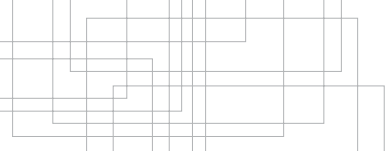



FIRE

Fires that break out in the buildings and spread very rapidly cause a high level of destruction. For this reason, subjects relating to fire safety have to be handled carefully extremely at the design stage of the building and materials selection is vitally important. The main purpose of ensuring fire safety is to minimize the degree of destruction arising from an outbreak of fire.

FIRE

When providing fire safety, above all else, the type of building and room in which the suspended ceiling system to be installed is important. During the initial stages of a fire there are three critical conditions to be considered.

- Suspended ceilings should not contribute to the spread of the fire or the formation of smoke. This may be ensured by the use of suspended ceiling systems that conform to the Euro class B-s1 (s2) d0 class of reaction to fire.
- While rescue and evacuation operations are conducted during the early stages of the fire, suspended ceiling systems should not be demolished or collapse. This is possible with suspended ceiling systems capable of withstanding heat up to approximately 300°C.
- Suspended ceiling systems should not include any combustible materials.

Reaction to Fire performance classes for building materials other than flooring

B	s1,	d
Basic class	Smoke class formation	Flame draplet

- **Basic classes**
A1, A2, B,C,D, E and F (A1; the best, F; the worst)
- **Smoke formation classes**
s1, s2, and s3 (s1;the best)
- **Flame dripping classes**
d0, d1,d2, (d0; the best)

Fire reaction class- Euroclass (EN 13501-1) standard

A1		
A2-s1,d0	A2-s1,d1	A2-s1,d2
A2-s2,d0	A2-s2,d1	A2-s2,d2
A2-s3,d0	A2-s3,d1	A2-s3,d2
B-s1,d0	B-s1,d1	B-s1,d2
B-s2,d0	B-s2,d1	B-s2,d2
B-s3,d0	B-s3,d1	B-s3,d2
C-s1,d0	C-s1,d1	C-s1,d2
C-s2,d0	C-s2,d1	C-s2,d2
C-s3,d0	C-s3,d1	C-s3,d2
D-s1,d0	D-s1,d1	D-s1,d2
D-s2,d0	D-s2,d1	D-s2,d2
D-s3,d0	D-s3,d1	D-s3,d2
E		
E-d2		
F		



FIRE

Fire reaction performance classes for building materials other than flooring

Inflammables Feature of the Material	No Smoke Formation	No Burning/ Dripping Particles	European class (as per TS EN 135011 Inflammables)
Inflammables	X	X	A1
Hard-flammable	X	X	A2 - s1,d0
Hard flaming	X	X	B, C - s1,d0
		X	A2 - s2,d0 A2, B, C - s3,d0
	X		A2, B, C - s1,d1 A2, B, C - s1,d2
(minimum)			A2, B, C - s3,d2
Normal flaming		X	D - s1,d0 D - s2,d0 D - s3,d0 E
			D - s1,d2 D - s2,d2 D - s3,d2
(minimum)			E - d2
Easy-flaming			F

Fire reaction classes for INTEGRA metal ceiling panels subjected to tests in international institutes and laboratories in accordance with EN 13501-1 standard

FIRE REACTION CLASS	WITHOUT FABRIC	ROYALIN -FABRIC
Galvanized steel	B-s1,d0	B-s1,d0
Aluminum	B-s1,d0	B-s1,d0

All fire reports required for perforated Integra metal ceiling panels, whether with acoustic fabric or not, can be obtained upon request from Integra head office.

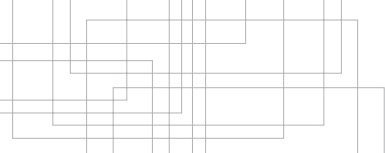



MAINTENANCE GUIDE

Field Cutting

Metal ceilings may need to be field cut to accommodate special conditions: less than full module perimeters, columns penetrating the ceiling etc. Such cuts should be made by competent craftsmen using appropriate tools: duct snips, electric sheet metal shears or hand-saws. Extreme care must be exercised to prevent damage to painted surfaces or buckling and distortion. Cut edges should be concealed with the appropriate trim.

Cleaning and Maintenance

Dust should be removed from painted surfaces by wiping with a clean soft cloth. Grease and finger prints should be removed with a mild household cleaner suitable for painted surfaces. Do not use abrasive cleaners or scrub the surface.

Storage and Transportation

Ceiling components should be stored under conditions of use in a dry interior location and should remain in cartons until installation. Care must be exercised during the handling and opening of cartons to avoid damage



Offering high quality
solutions to all interior
dimensions

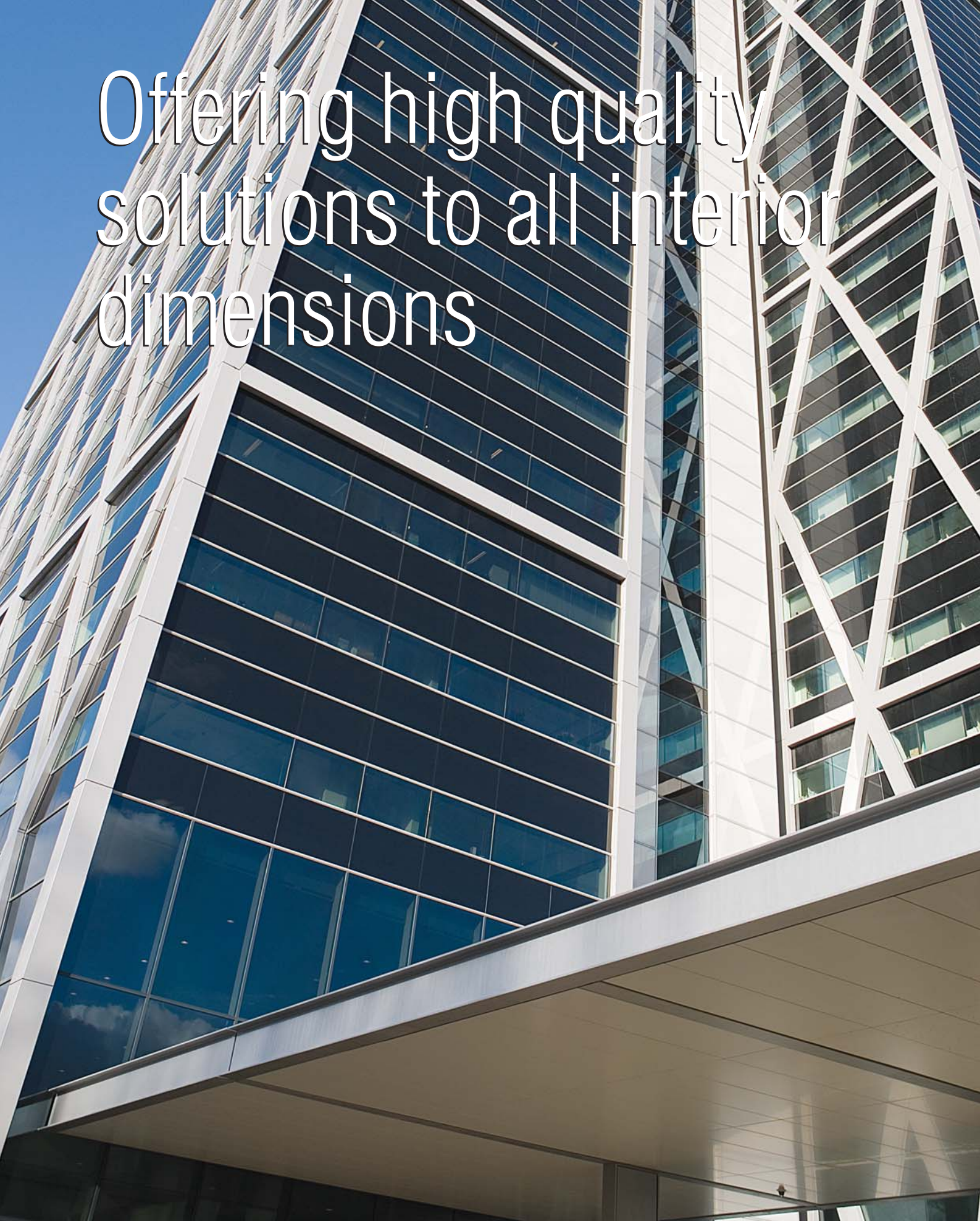



Integra offers wide range of high quality products through its extensive line of design alternatives and options incorporation the Tile, Plank, Open Cell, Expanded and fully customised ceiling systems, all of which can be supplied in different shapes, colours and sizes.





Better quality in living and working spaces

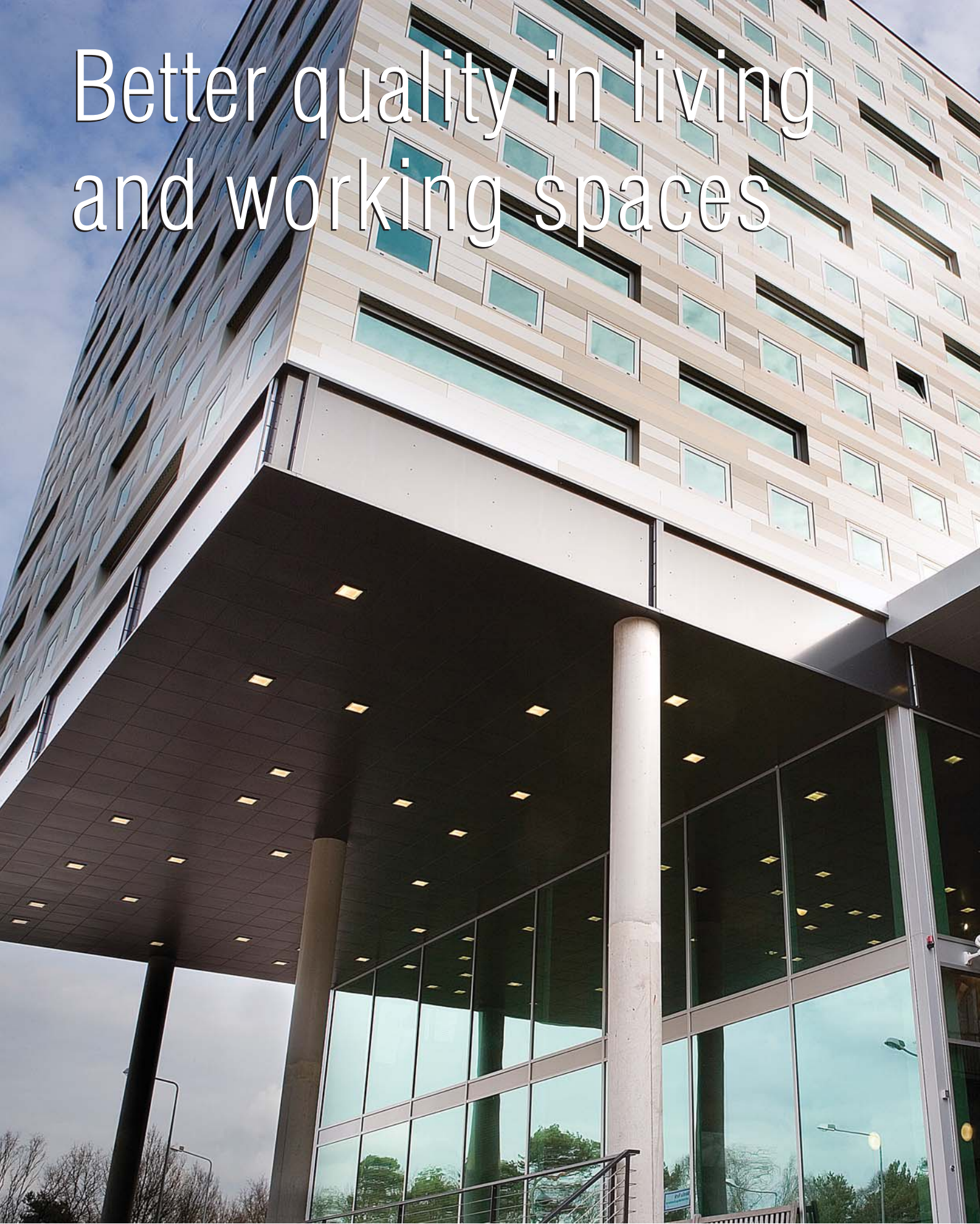

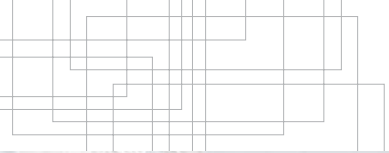



TILE

METAL CEILING SYSTEMS



INTEGRA METAL CEILING SYSTEMS B.V.

Rak 22 - 1551 NA Westzaan
Postbus 2067 - 1500 GB Zaandam
Tel. +31 (0)75 614 87 22
Fax. +31 (0)75 670 14 97
Internet : www.metalenplafonds.nl
E-mail : info@metalenplafonds.nl